

1

An electric current was passed through dilute sulphuric acid. The apparatus used is shown. Oxygen was formed at the anode.

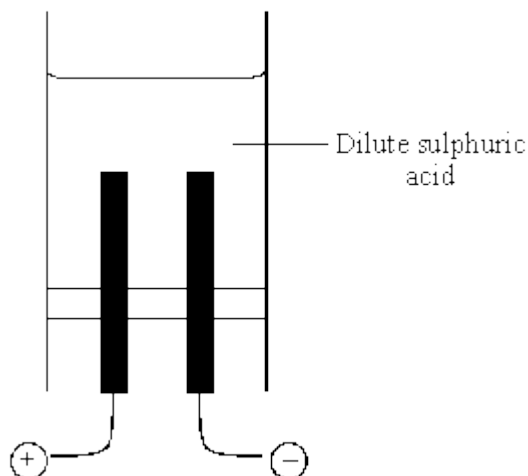

(a) What name is given to solutions which decompose when electricity is passed through them?

.....

(1)

(b) The ionic equation for the reaction at the anode is:

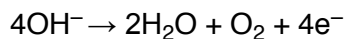

Explain this type of reaction.

.....

(2)

(c) Write a **balanced** ionic equation for the reaction at the cathode.

.....

(2)

(d) What happens to the concentration of the sulphuric acid as the electricity is passed through it? Explain your answer.

.....

(3)

(Total 8 marks)

2

The diagram shows electrolysis of sodium chloride solution.

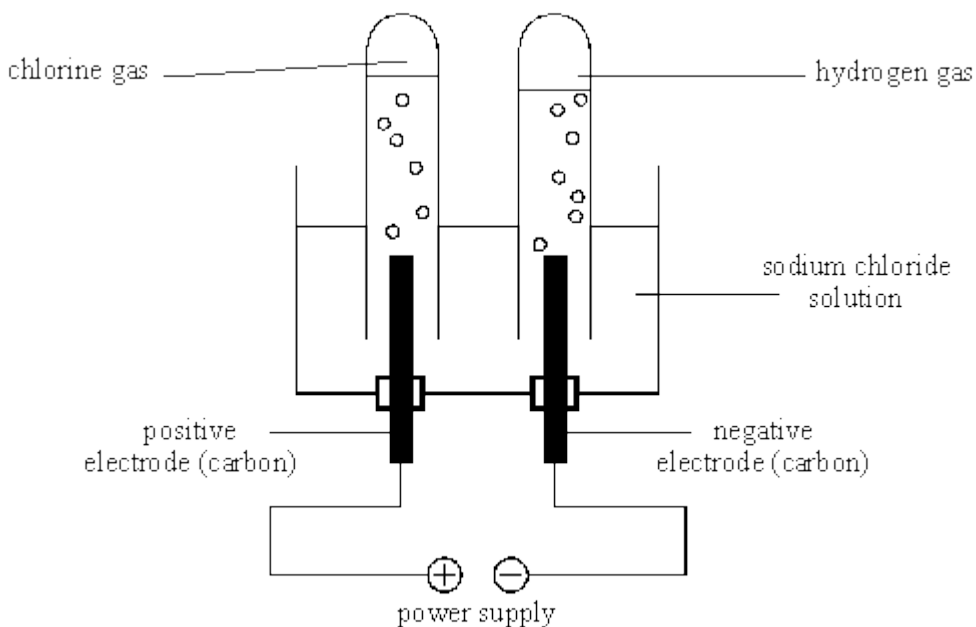

(a) Complete and balance these equations to show the reactions during electrolysis.

At the positive electrode

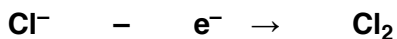

At the negative electrode



(2)

(b) Silver halides such as silver chloride and silver bromide are used in photography. The equation shows a reaction to prepare a silver halide.

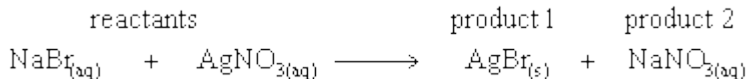

Name and describe the products of this reaction, in words, as fully as you can.

product 1

.....
.....

product 2

.....
.....

(4)

(Total 6 marks)

3

The electrolysis of sodium chloride solution is an industrial process.

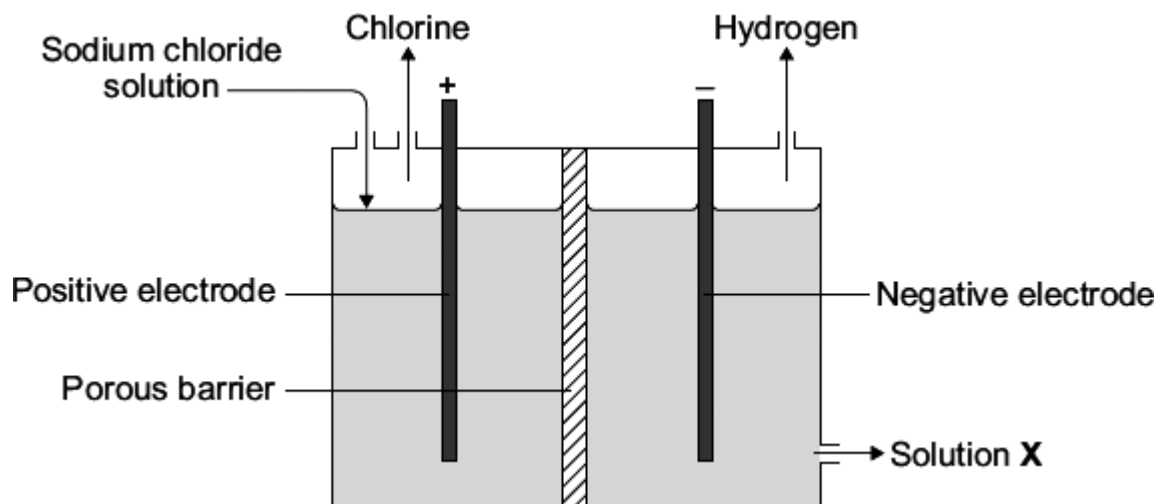

(a) Why do chloride ions move to the positive electrode?

.....

(1)

(b) Sodium chloride solution contains two types of positive ions, sodium ions (Na^+) and hydrogen ions (H^+).

Tick (✓) the reason why hydrogen is produced at the negative electrode and **not** sodium.

Reason	Tick (✓)
Hydrogen is a gas.	
Hydrogen is less reactive than sodium.	
Hydrogen is a non-metal.	
Hydrogen ions travel faster than sodium ions.	

(1)

(c) Solution X is alkaline.

Which ion makes solution X alkaline?

.....

(1)

(d) Electrolysis of sodium chloride solution produces hydrogen and chlorine.
The hydrogen and chlorine can be used to make hydrogen chloride.

(i) The diagrams show how the outer electrons are arranged in atoms of hydrogen and chlorine.

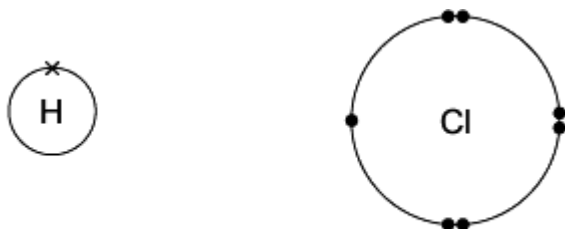

Hydrogen atom

Chlorine atom

Complete the diagram to show how the electrons are arranged in a molecule of hydrogen chloride (HCl).

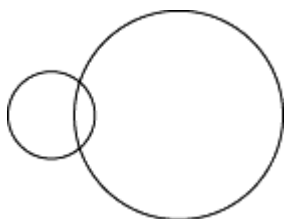

(1)

(ii) Name the type of bond between the hydrogen and the chlorine atoms in a molecule of hydrogen chloride.

.....

(1)

(iii) Some hydrogen chloride was bubbled into water. This made a solution with a pH of 1.

Which ion gave the solution a pH of 1?

.....

(1)

(Total 6 marks)

4

The diagram below shows the electrolysis of sodium chloride solution, in the laboratory.

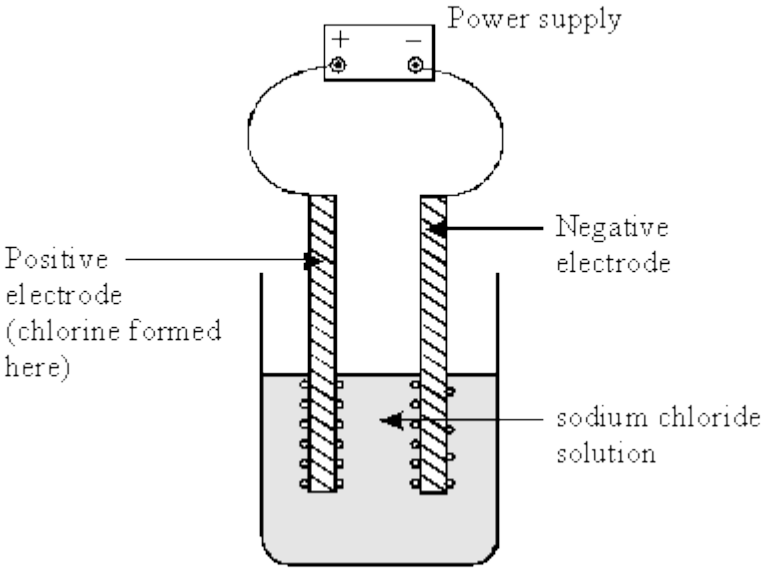

(a) Which gas forms at the negative electrode?

(1)

(b) Explain why chlorine gas forms at the positive electrode.

.....
.....
.....

(2)

(c) State **one** use of chlorine gas.

.....

(1)

(Total 4 marks)

Read the passage carefully and then answer the questions.

The electrolysis of acidified water

After a few drops of dilute sulphuric acid have been added to some distilled water, there will be three types of ion in solution:

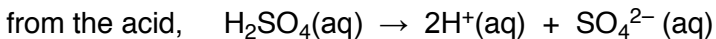
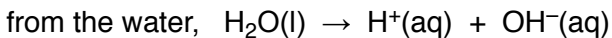

When the electrodes (anode and cathode) in a circuit are put into the acidified water, the hydroxide ions and the sulphate ions are both attracted to the electrode called the anode. However, it is harder for the sulphate ions to give up their electrons than for the hydroxide ions to do this. So the hydroxide ions are the ones which react and bubbles of oxygen are formed at the anode.

There are only hydrogen ions to be attracted towards the cathode and, when they get there, they take up electrons to form hydrogen molecules.

From Chemistry Matters by Richard Hart, reproduced by permission of Oxford University Press

Even in a small volume of water acidified with dilute sulphuric acid there will be billions of ions. Some will be anions and some will be cations.

- (i) Name the ions in water acidified with dilute sulphuric acid.

.....

(1)

- (ii) Explain why only some of the ions are attracted to the anode.

.....

.....

.....

(2)

- (iii) Balance the equation for the reaction of hydroxide ions at the anode.

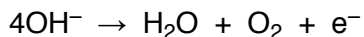

(1)

(Total 4 marks)

6

The electrolysis of sodium chloride solution is an important industrial process. Three useful substances are produced:

- chlorine gas is formed at the positive electrode;
- hydrogen gas is formed at the negative electrode;
- an alkali is left in the solution.

The reactions which take place at the electrodes are represented by the equations shown below:

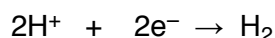
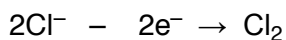

(a) Name the important alkali which is left in the solution.

.....

(1)

(b) State why chloride ions move towards the positive electrode.

.....

(1)

(c) Why is the formation of chlorine at this electrode said to be an oxidation reaction?

.....

(1)

(Total 3 marks)

7

Sodium hydroxide, hydrogen and chlorine can all be made in one industrial process. Electricity is passed through aqueous sodium chloride solution (brine). The diagram below shows a cell that can be used for this process.

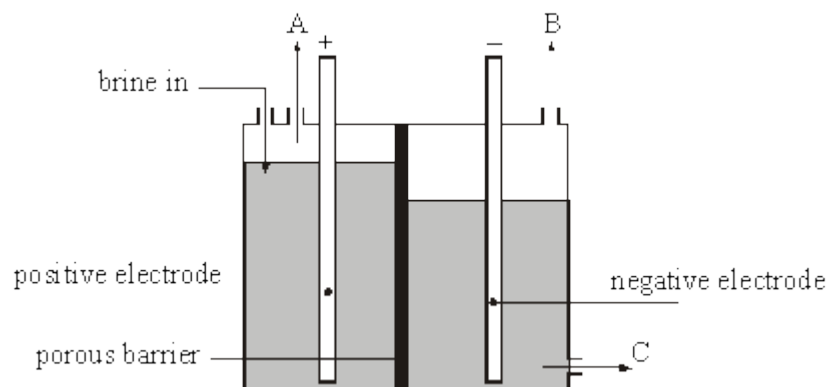

(a) Name A, B and C.

Gas A

Gas B

Solution C

(2)

(b) Balance the equations for the reactions at the electrodes.

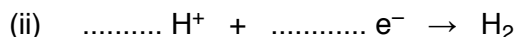
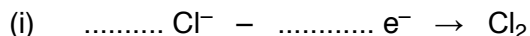

(2)

(c) Name the compound in this cell which produces the hydrogen ions.

.....

(1)

(d) Which type of particles must be able to pass through the barrier to allow the electrolysis to take place?

.....

(1)

(Total 6 marks)

8

(a) In an industrial process electricity is passed through a solution of sodium chloride in water. A student set up the apparatus shown below to investigate this process.

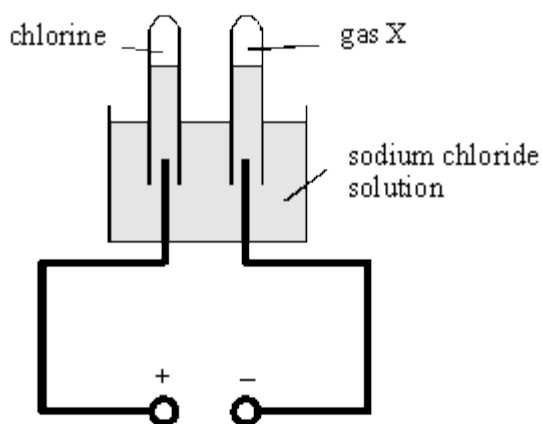

(i) Name gas X.

.....

(1)

(ii) Complete the half equation for the production of chlorine gas during the electrolysis.



(1)

(iii) The student found that the solution left in the cell was alkaline.

Which ion makes the solution alkaline?

.....

(1)

(iv) Name the useful substance that can be obtained from the solution in the cell.

.....

(1)

(b) Sodium carbonate is another useful chemical that can be made from sodium chloride. The flow chart below shows one way in which sodium carbonate can be made.

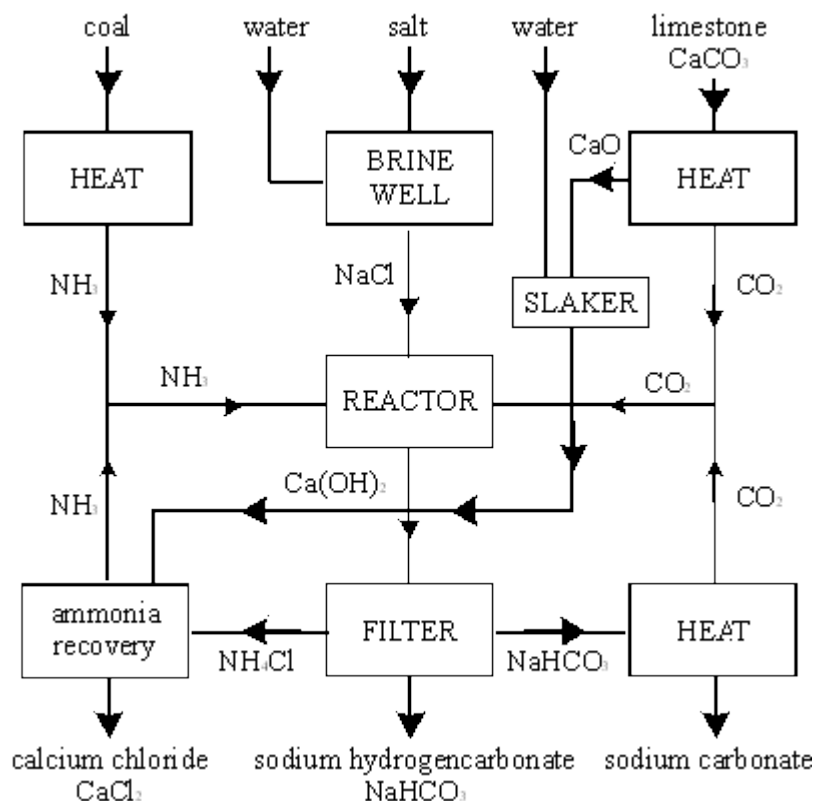

(i) Write the formula of sodium carbonate.
Use the Data Sheet to help you to answer this question.

.....

(1)

(ii) Salt is one raw material used in this process.

Name **one** other raw material used in this process.

.....

(1)

(iii) Sodium carbonate is one of the products of this process.

Name **one** other product.

.....

(1)

(iv) 1. Give **one** example of a thermal decomposition reaction shown in the flow chart.

.....

.....

(1)

2. Explain what is meant by a thermal decomposition reaction.

.....

.....

(2)

(v) Name **one** substance that is recycled in this process.

.....

(1)

(c) When sodium carbonate solution is added to zinc sulphate solution a white solid is precipitated.

(i) Use the Data Sheet to help you to name the white solid that is produced in this reaction.

.....

(1)

(ii) State why this solid is formed.

.....

.....

.....

(1)

(Total 13 marks)

9

An investigation into the *electrolyte* copper sulphate solution was carried out as shown.

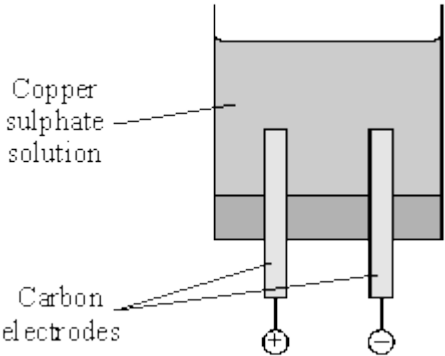

(a) What does *electrolyte* mean?

.....
.....
.....

(2)

(b) These were the observations.

Negative electrode	solid formed
Positive electrode	gas given off

(i) Name the solid formed.

.....

(1)

(ii) Name the gas given off.

.....

(1)

(c) How could a sample of gas be collected at the positive electrode?

.....
.....

(2)

(d) Suggest why the blue colour of copper sulphate becomes paler during the investigation.

.....
.....

(2)

(Total 8 marks)

10

A student investigated the *electrolysis* of lead bromide.

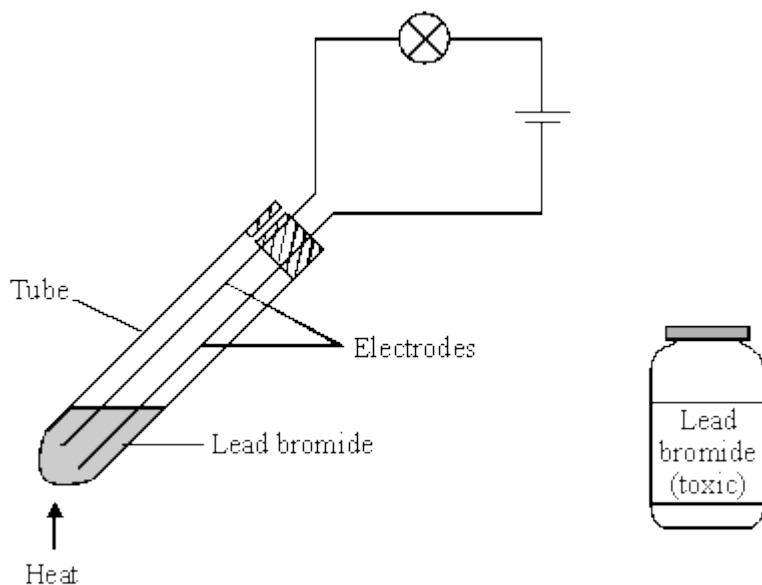

Lead bromide was placed in the tube and the circuit was switched on. The light bulb did not light up.

The tube was heated and soon the bulb lit up. The observations are shown in the table.

Positive electrode	Negative electrode
red-brown gas	silver liquid

(a) What is meant by *electrolysis*?

.....

(2)

(b) Why did the lead bromide conduct electricity when the tube was heated?

.....

(1)

(c) Name the substances formed at the:

positive electrode;

negative electrode.

(2)

(d) Suggest **one** safety precaution that should be taken during this investigation.

.....

(1)

(Total 6 marks)

Sodium chloride solution is a useful raw material for the manufacture of other substances.

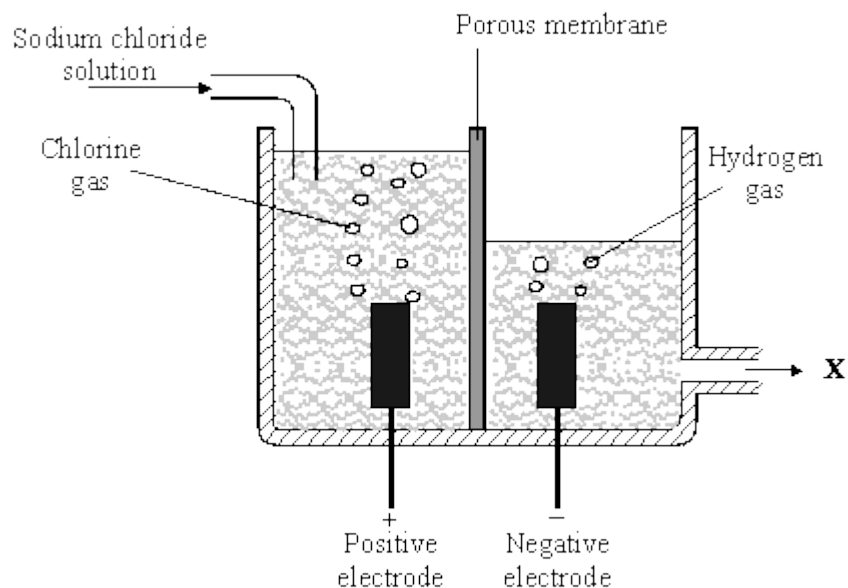

- (i) What is the name of the process shown?

.....

(1)

- (ii) Chloride ions lose electrons at the positive electrode. What is the name of this type of reaction?

.....

(1)

- (iii) The solution formed at **X** is alkaline. What causes this solution to be alkaline?

.....

.....

.....

(2)

- (iv) Give a balanced ionic equation for the formation of hydrogen gas at the negative electrode.

.....

(3)

(Total 7 marks)

12

The electrolysis of sodium chloride solution is an important industrial process. The apparatus shown below can be used to show this electrolysis in the laboratory.

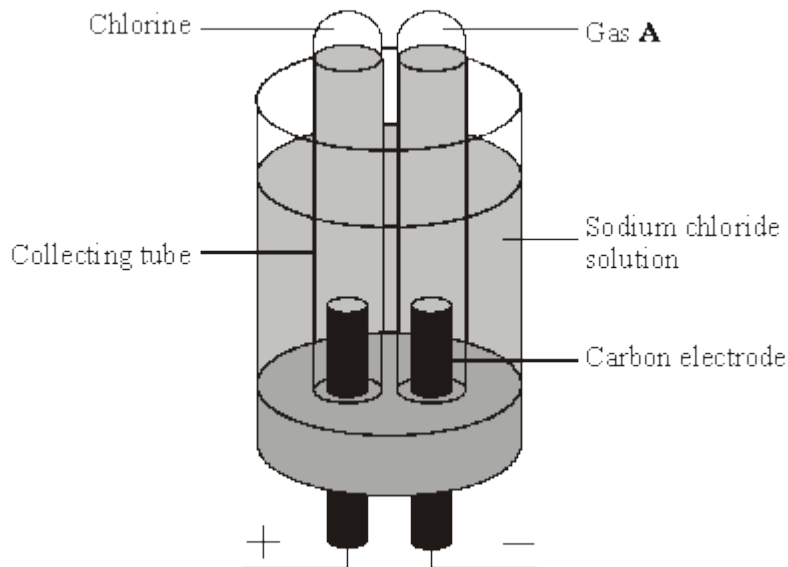

(a) Name gas A.

(1)

(b) Chlorine is produced at the positive electrode. Describe and give the result of a chemical test to prove that the gas is chlorine.

.....
.....
.....
.....

(2)

(c) Chloride ions move to the positive electrode. Explain why.

.....
.....

(1)

(d) A small quantity of chlorine is added to drinking water. Explain why.

.....
.....

(1)

- (e) The solution around the negative electrode becomes alkaline. Name the ion which makes the solution alkaline.

.....

(1)
 (Total 6 marks)

13

- (a) Two experiments were set up as shown.

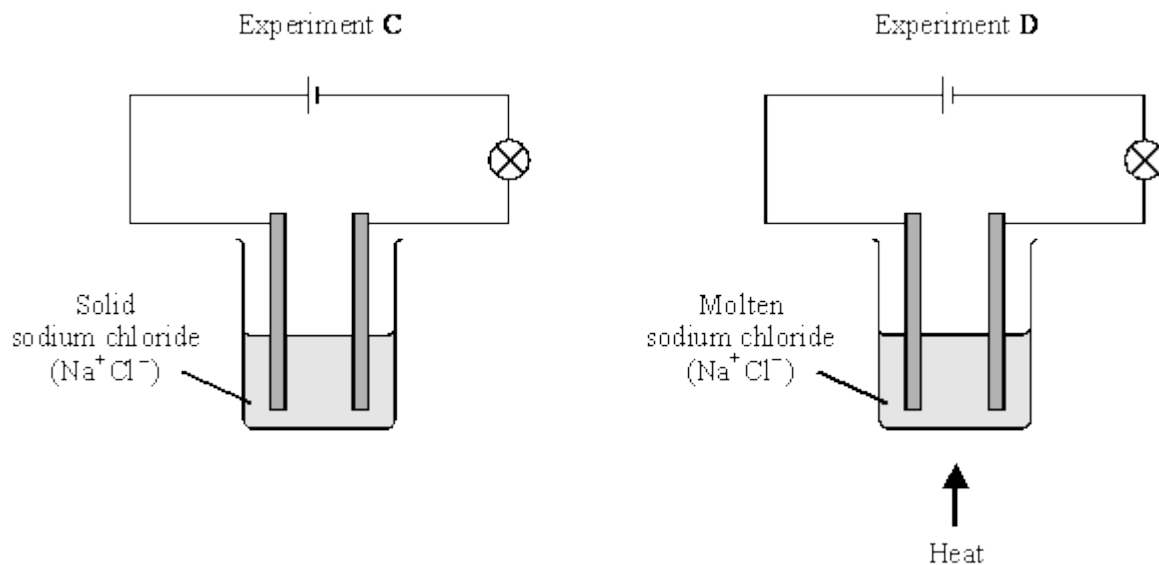

- (i) Give **two** observations which would be seen only in Experiment D.

1

2

(2)

- (ii) Explain why in Experiment C no changes would be seen.

.....

(2)

(b) Another *electrolysis* experiment used an aqueous solution of copper chloride.

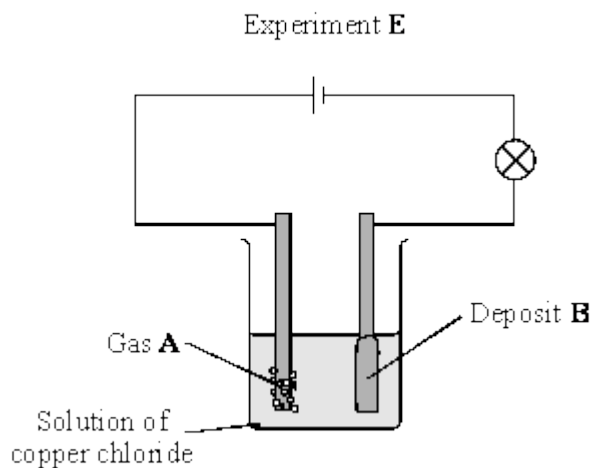

(i) What does *electrolysis* mean?

.....

.....

.....

(2)

(ii) Name the gas **A** and the deposit **B**.

Gas **A**

.....

(2)

(c) Give **one** industrial use of electrolysis.

.....

(1)

(Total 9 marks)

14

A student investigated the electrolysis of copper sulfate solution. The student's method is shown below.

Two clean pieces of copper were weighed. One piece was used as the positive electrode and the other piece was used as the negative electrode. The circuit was set up as shown in the diagram.

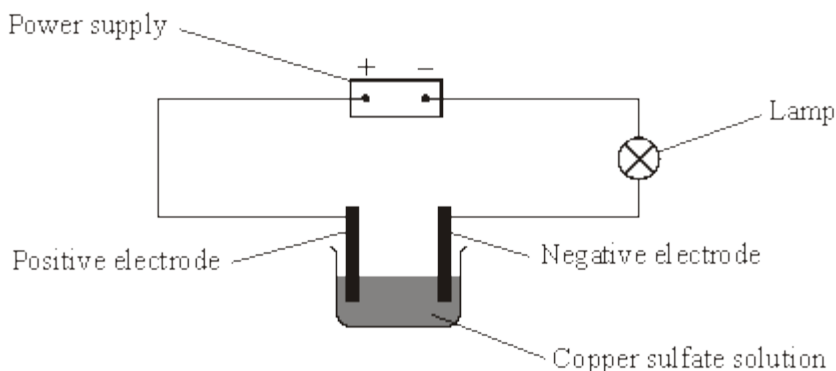

After the electrolysis, the pieces of copper were:

- washed with distilled water
- washed with propanone (a liquid with a lower boiling point than water)
- allowed to dry
- weighed.

(a) Explain why the electrode would dry faster when washed with propanone instead of water.

.....
.....

(1)

(b) The student's results are given in the table.

	Positive electrode	Negative electrode
mass of electrode before electrolysis, in grams	16.41	15.46
mass of electrode after electrolysis, in grams	16.10	15.75

The mass of the positive electrode decreased by 0.31 g.

(i) What is the change in mass of the negative electrode? g

(1)

- (ii) The mass lost by the positive electrode should equal the mass gained by the negative electrode.

Suggest **two** reasons why the results were **not** as expected.

1

.....

2

.....

(2)

- (c) Describe and explain how electrolysis is used to make pure copper from a lump of impure copper.

.....

.....

.....

.....

.....

.....

.....

.....

(4)

(Total 8 marks)

15

The *electrolysis* of sodium chloride solution produces useful substances.

- (a) Explain the meaning of *electrolysis*.

.....

.....

.....

.....

(2)

(b) The diagram shows an apparatus used for the electrolysis of sodium chloride solution.

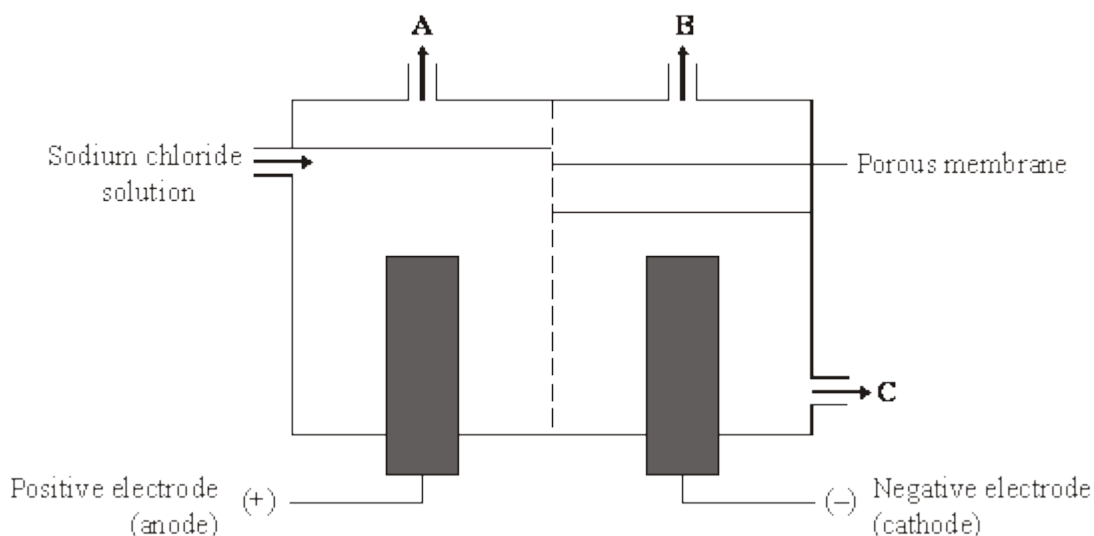

Reproduced with the permission of Nelson Thornes Ltd from PATRICK FULLICK et al, ISBN 0-7487-9644- 4. First published in 2006

The electrolysis produces two gases, chlorine and Gas **A**.

Name Gas **A**

(1)

(c) The electrodes used in this process can be made of graphite. Explain why graphite conducts electricity.

.....

(2)

(Total 5 marks)

16

The electrolysis of sodium chloride solution produces useful substances.

(a) (i) Choose a word from the box to complete the sentence.

covalent	ionic	non-metallic
----------	-------	--------------

Electrolysis takes place when electricity passes through
 compounds when they are molten or in solution.

(1)

(ii) Choose a word from the box to complete the sentence.

alkenes	elements	salts
----------------	-----------------	--------------

During electrolysis the compound is broken down to form.....

(1)

(b) The table of ions on the Data Sheet may help you to answer this question.

The diagram shows an apparatus used for the electrolysis of sodium chloride solution.

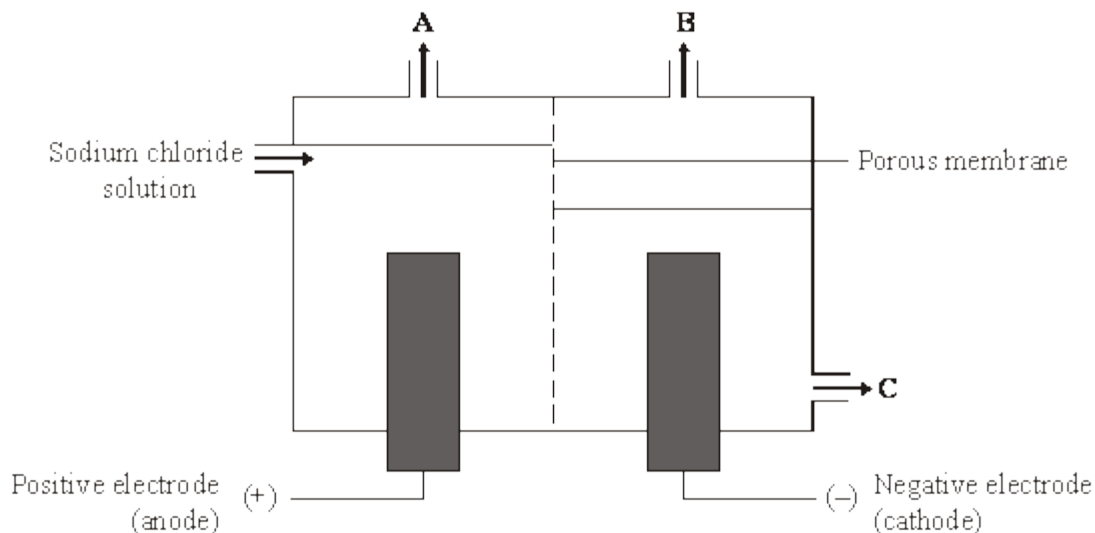

Reproduced with the permission of Nelson Thornes Ltd from PATRICK FULLICK et al, ISBN 0-7487-9644- 4. First published in 2006

Identify the products **A**, **B** and **C** on the diagram using substances from the box.

chlorine gas	hydrogen gas	oxygen gas
sodium hydroxide solution		sodium metal

(i) **A** is

(1)

(ii) **B** is

(1)

(iii) **C** is

(1)

(Total 5 marks)

17

Sodium chloride is a raw material.

(a) The electronic structure of a sodium atom is shown below.

Complete the diagram for the electronic structure of a chlorine atom. A chlorine atom has 17 electrons.

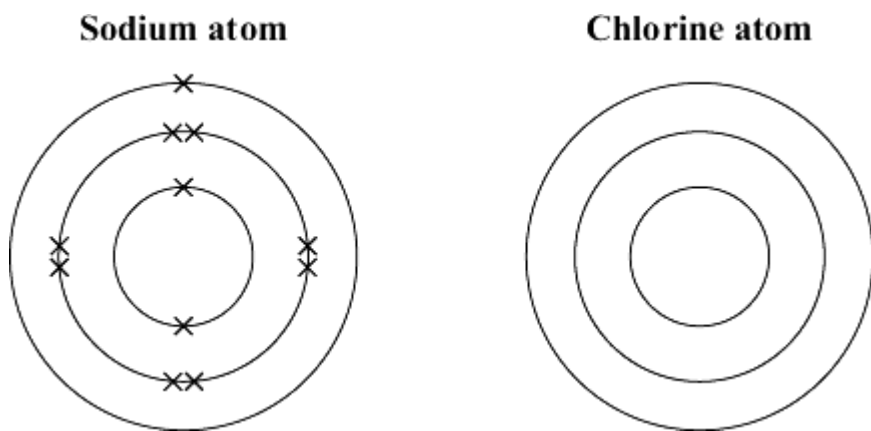

(1)

(b) When sodium and chlorine react to form sodium chloride they form sodium ions (Na^+) and chloride ions (Cl^-).

How does a sodium atom change into a sodium ion?

.....
.....
.....
.....

(2)

- (c) The diagram shows apparatus used in a school laboratory for the electrolysis of sodium chloride solution.

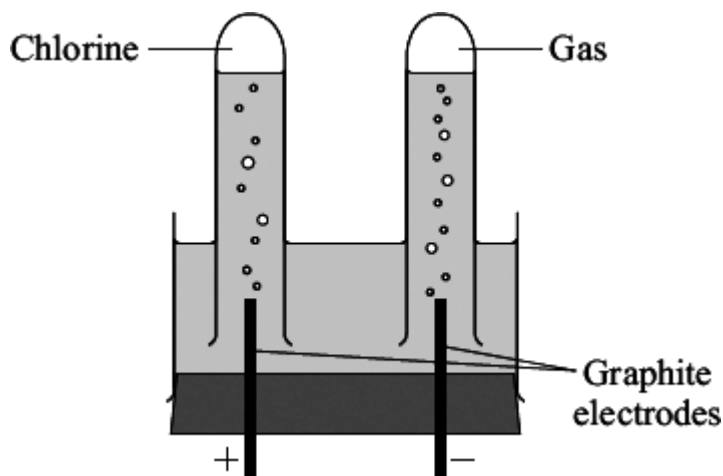

The solution contains sodium ions (Na^+), chloride ions (Cl^-), hydrogen ions (H^+) and hydroxide ions (OH^-).

- (i) Why do chloride ions move to the positive electrode?

.....

(1)

- (ii) Name the gas formed at the negative electrode.

.....

(1)

- (d) Chlorine and chlorine compounds are used to bleach wood pulp that is used to make paper.

The article below is from a newspaper.

Local people have been protesting outside a paper factory. They say:
 ‘We want the company to stop using chlorine compounds. Chlorine compounds release poisons into the environment. The company should use safer compounds.’

The company replied:
 ‘Chlorine has been used safely for many years to treat drinking water. Only tiny amounts of chlorine are released, which cause no harm. Using other compounds will be more expensive and may put us out of business.’

- (i) Why are some local people worried about the use of chlorine compounds?

.....

.....

(1)

- (ii) Why might other local people want the company to continue to use chlorine compounds?

.....
.....

(1)

- (iii) It is decided to have an inquiry.
Why should this be done by independent scientists?

.....
.....

(1)

(Total 8 marks)

18

Electroplating is used to coat a cheap metal with a thin layer of an expensive metal.

In the diagram a teaspoon made of nickel is being coated with silver.

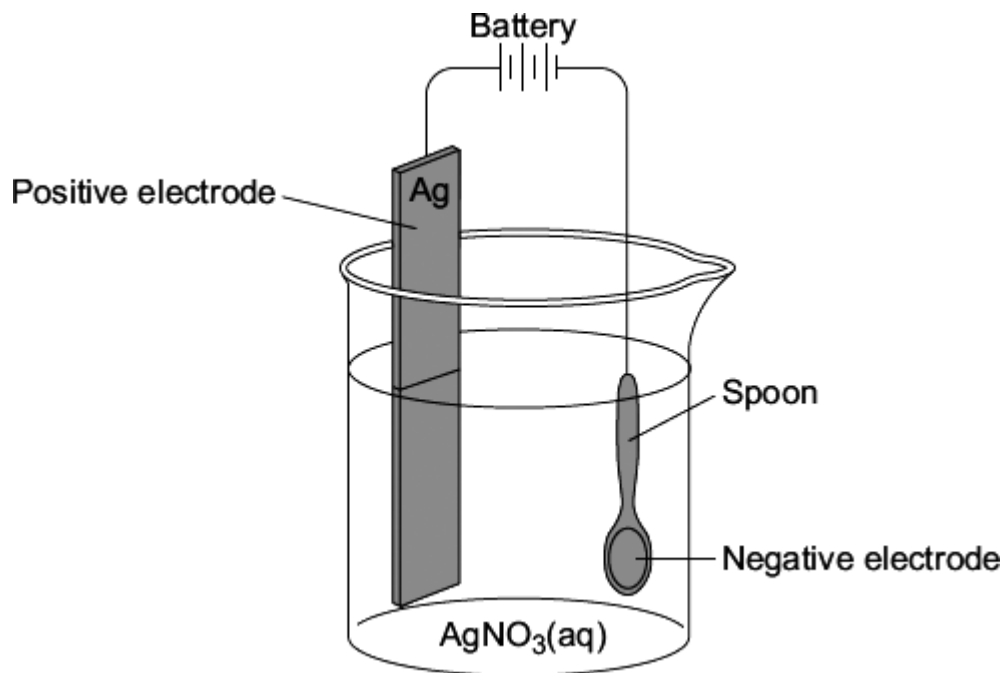

Silver nitrate, AgNO_3 , contains silver ions (Ag^+) and nitrate ions (NO_3^-).

- (a) Solid silver nitrate, $\text{AgNO}_3(\text{s})$, does **not** conduct electricity.

Choose the correct answer in the box to complete the sentence.

are too big	cannot move	are too small
-------------	-------------	---------------

Solid silver nitrate does **not** conduct electricity because the ions

.....

(1)

(b) What substance is added to $\text{AgNO}_3(\text{s})$ to turn it into $\text{AgNO}_3(\text{aq})$?

Draw a ring around the correct answer.

petrol

alcohol

water

(1)

(c) Draw a ring around the correct answer to complete each sentence.

(i) Silver ions move to the negative electrode because they have

no charge.
a negative charge.
a positive charge.

(1)

(ii) When silver ions reach the negative electrode they turn into silver

atoms
compounds.
molecules.

(1)

(Total 4 marks)

The diagram shows apparatus used by a student to investigate electrolysis.

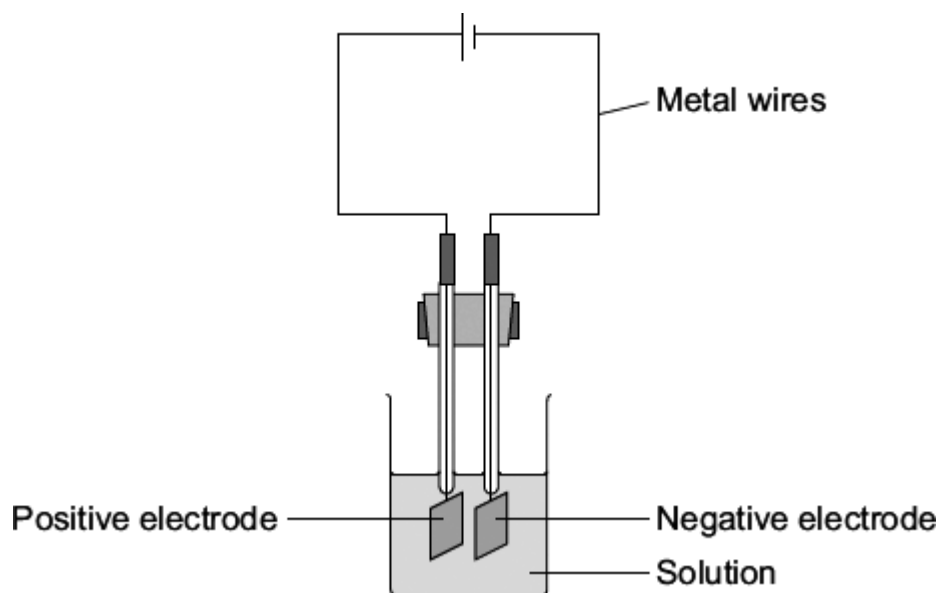

The student was given a solution by the teacher. The solution contained a mixture of ionic compounds.

(a) Name the particles which carry the electric current through:

(i) the metal wires

(1)

(ii) the solution.

(1)

(b) The table shows the ions in the solution.

Positive ions in the solution	Negative ions in the solution
Zinc ion (Zn^{2+})	Chloride ion (Cl^-)
Iron(III) ion (Fe^{3+})	Hydroxide ion (OH^-)
Hydrogen ion (H^+)	Nitrate ion (NO_3^-)
Copper(II) ion (Cu^{2+})	Sulfate ion (SO_4^{2-})

The reactivity series on the Data Sheet may help you to answer this question.

(i) Which element is most likely to be formed at the negative electrode?

.....

(1)

(ii) Explain, as fully as you can, why you have chosen this element.

.....
.....
.....
.....

(2)

(c) The electrolysis of sodium chloride solution is an industrial process.

(i) The reaction at one of the electrodes can be represented by the equation shown below.



The chloride ions (Cl^-) are oxidised.

Explain why.

.....
.....

(1)

(ii) The reaction at the other electrode can be represented by an equation.

Complete and balance the equation for the reaction at the other electrode.



(1)

(Total 7 marks)

A student investigated the electrolysis of sodium chloride solution.

Five sodium chloride solutions were made. Each solution had a different concentration.

To make each solution the student:

- weighed the amount of sodium chloride needed
- dissolved it in water
- added more water until the total volume was one cubic decimetre (1 dm³).

The solutions were placed one at a time in the apparatus shown below.

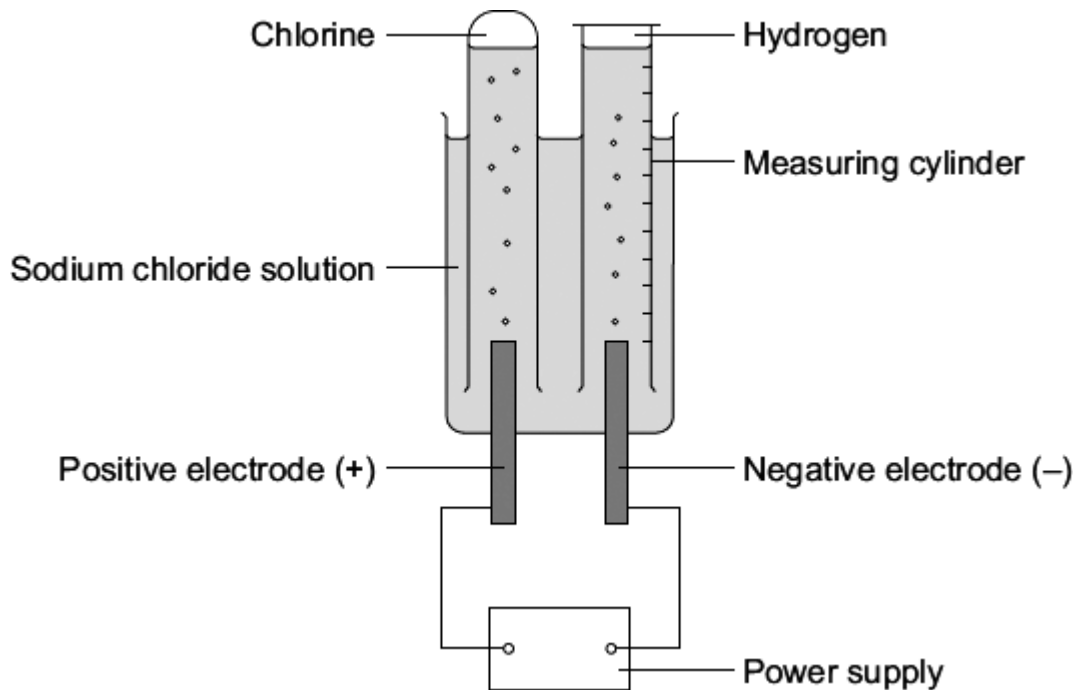

The student measured the volume of hydrogen gas produced in ten minutes.

The results are shown on the graph below.

(a) Sodium chloride does not conduct electricity when it is solid.

Explain, in terms of ions, why sodium chloride solution conducts electricity.

.....

.....

(1)

(b) Chlorine is produced at the positive electrode.

Why are chloride ions attracted to the positive electrode?

.....

(1)

(c) The solution left at the end of each experiment contains sodium hydroxide.

Draw a ring around **one** number which could be the pH of this solution.

2 5 7 13

(1)

(d) The results for the experiment above are shown on the graph.

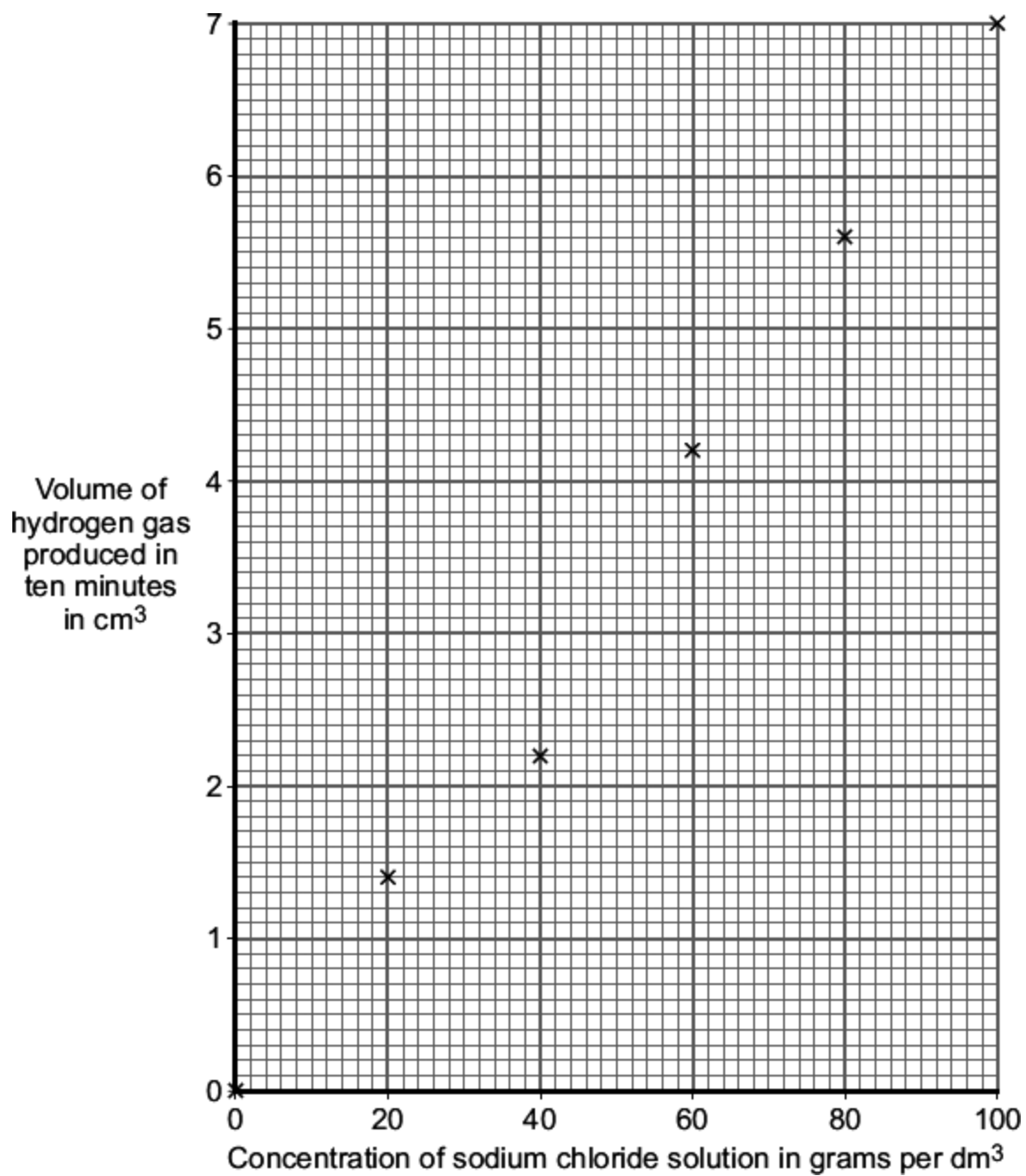

(i) Draw a line of best fit on the graph.

(1)

- (ii) The result for one concentration is anomalous.
Which result is anomalous?

The result at concentration grams per dm³

(1)

- (iii) Suggest **two** possible causes of this anomalous result.

1

.....

2

.....

(2)

- (iv) Suggest how the student could check the reliability of the results.

.....

.....

(1)

- (iv) How did an increase in the concentration of the sodium chloride solution affect the volume of hydrogen gas produced in ten minutes?

.....

.....

(1)

(Total 9 marks)

21

Humphrey Davy was a professor of chemistry.

In 1807 Humphrey Davy did an electrolysis experiment to produce potassium.

- (a) (i) Humphrey Davy was the first person to produce potassium.

Draw a ring around the correct answer to complete each sentence.

Humphrey Davy's experiment to produce this new element was quickly accepted by

other scientists because he

had a lot of money.

had a lot of staff to help.

was well qualified.

(1)

(ii) Other scientists were able to repeat Davy's experiment.

Draw a ring around the correct answer to complete each sentence.

Being able to repeat Davy's experiment is important because

other scientists can

- | |
|--------------------------------------|
| check the results of the experiment. |
| see if the experiment is safe. |
| take the credit for the discovery. |

(1)

(b) A student tried to electrolyse potassium chloride.

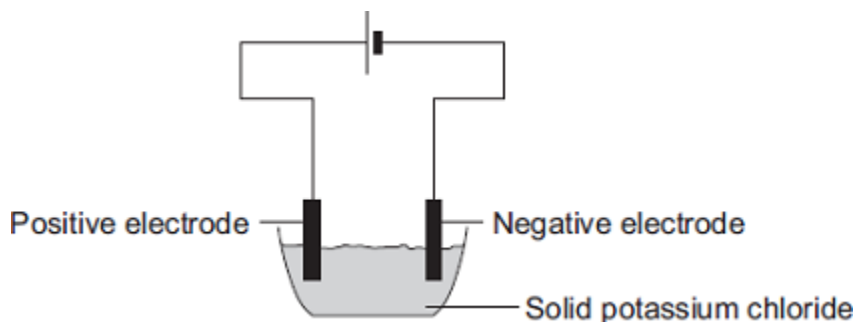

Potassium chloride contains potassium ions (K^+) and chloride ions (Cl^-).

(i) The student found that solid potassium chloride does not conduct electricity.

Use the correct answer from the box to complete the sentence.

- | | | |
|--------------------|--------------------|-----------------------|
| are too big | cannot move | have no charge |
|--------------------|--------------------|-----------------------|

Solid potassium chloride does not conduct electricity because
the ions

(1)

(ii) What could the student do to the potassium chloride to make it conduct electricity?

.....

(1)

(iii) During electrolysis why do potassium ions move to the negative electrode?

.....

(1)

(iv) Draw a ring around the correct answer to complete the sentence.

When the potassium ions reach the negative electrode

they turn into potassium

- | |
|-------------|
| atoms. |
| electrodes. |
| molecules. |

(1)

(Total 6 marks)

22

Electroplating is used to coat a cheap metal with a thin layer of an expensive metal.

In the diagram a teaspoon made of nickel is being coated with silver.

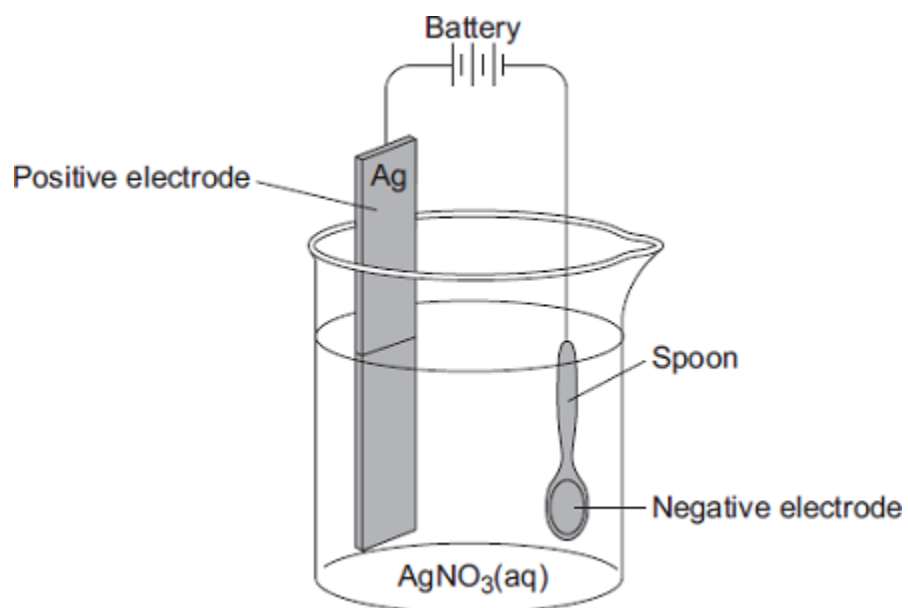

Silver nitrate (AgNO_3) contains silver ions (Ag^+) and nitrate ions (NO_3^-).

(a) Solid silver nitrate, $\text{AgNO}_3(\text{s})$, does **not** conduct electricity.

Choose the correct answer in the box to complete the sentence.

- | | | |
|-------------|-------------|---------------|
| are too big | cannot move | are too small |
|-------------|-------------|---------------|

Solid silver nitrate does **not** conduct electricity because the ions

.....

(1)

(b) Draw a ring around the correct answer to complete each sentence.

(i) Silver ions move to the negative electrode because they have

- no charge.
- a negative charge.
- a positive charge.

(1)

(ii) When silver ions reach the negative electrode they turn into silver

- atoms.
- compounds.
- molecules.

(1)

(Total 3 marks)

23

This question is about potassium.

(a) Humphrey Davy was a professor of chemistry.

In 1807 Davy did an electrolysis experiment to produce potassium.

(i) Davy first tried to electrolyse a solid potassium salt to produce potassium.

Explain why this electrolysis did **not** work.

.....

.....

.....

.....

(2)

(ii) Humphrey Davy was the first person to produce potassium.

Humphrey Davy's experiment to produce this new element was quickly accepted by other scientists.

Suggest why.

.....

.....

(1)

- (b) A student dissolved some potassium chloride in water. The student tried to electrolyse the potassium chloride solution to produce potassium.

The apparatus the student used is shown in the diagram.

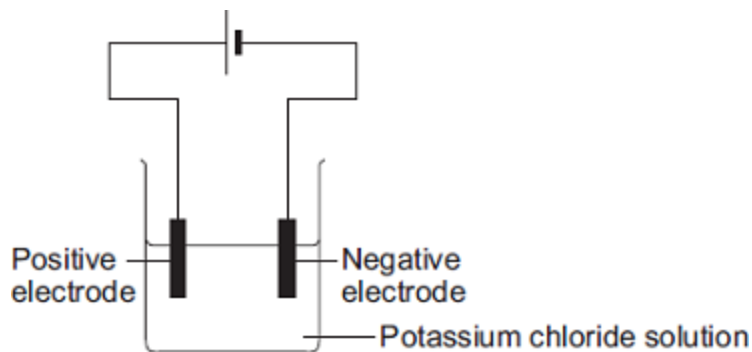

The student expected to see potassium metal at the negative electrode, but instead saw bubbles of a gas.

- Name the gas produced at the negative electrode.
- Explain why this gas was produced at the negative electrode **and** why potassium was not produced.

The reactivity series of metals on the Chemistry Data Sheet may help you to answer this question.

.....

.....

.....

.....

.....

.....

.....

(3)

- (c) The student tried to electrolyse molten potassium chloride to produce potassium.

- (i) Potassium metal was produced at the negative electrode.

Describe how potassium atoms are formed from potassium ions.

.....

.....

.....

.....

(2)

(ii) Complete and balance the equation for the reaction at the positive electrode.



(1)

(iii) Complete the diagram to show the electronic structure of a chloride ion (Cl^-).

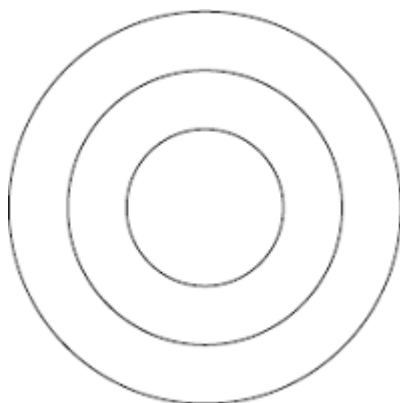

(1)

(Total 10 marks)

24

This question is about zinc.

Figure 1 shows the electrolysis of molten zinc chloride.

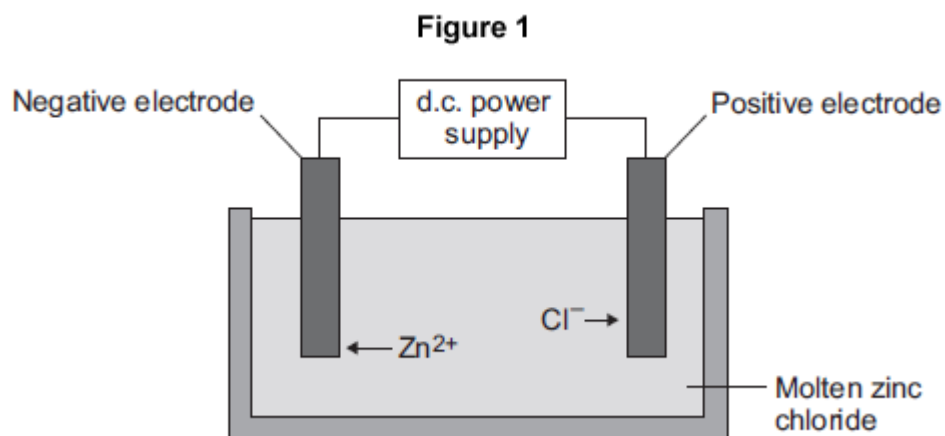

(a) Zinc chloride is an ionic substance.
Complete the sentence.

When zinc chloride is molten, it will conduct

(1)

(b) Zinc ions move towards the negative electrode where they gain electrons to produce zinc.

(i) Name the product formed at the positive electrode.

.....

(1)

(ii) Explain why zinc ions move towards the negative electrode.

.....
.....
.....
.....

(2)

(iii) What type of reaction occurs when the zinc ions gain electrons?

Tick (✓) **one** box.

Neutralisation	<input type="checkbox"/>
Oxidation	<input type="checkbox"/>
Reduction	<input type="checkbox"/>

(1)

(c) Zinc is mixed with copper to make an alloy.

(i) **Figure 2** shows the particles in the alloy and in pure zinc.

Figure 2

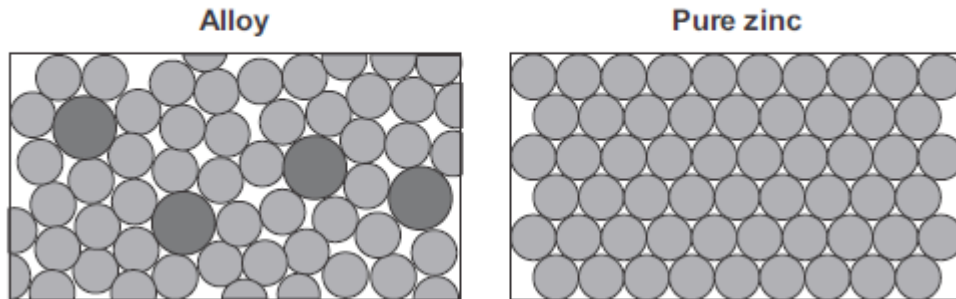

Use **Figure 2** to explain why the alloy is harder than pure zinc.

.....
.....
.....
.....

(2)

(ii) Alloys can be bent. Some alloys return to their original shape when heated.

What name is used for these alloys?

.....

(1)

(Total 8 marks)

25

The electrolysis of sodium chloride solution is an industrial process.

The diagram shows the apparatus used in a school experiment.

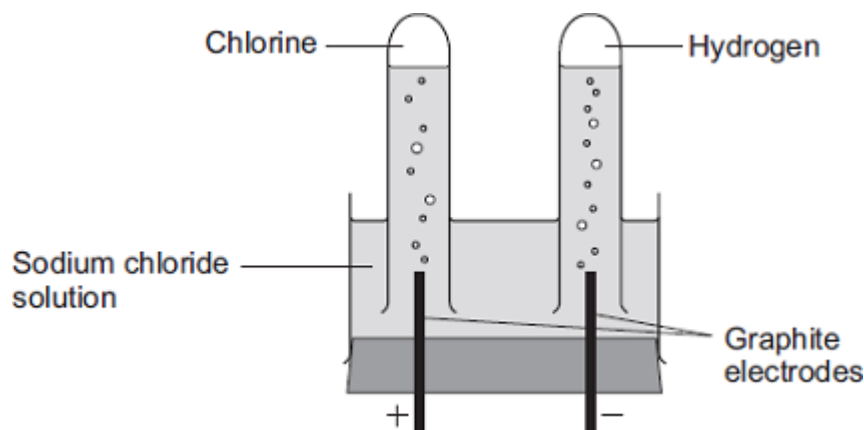

(a) One of the products of the electrolysis of sodium chloride solution is hydrogen.

(i) Why do hydrogen ions move to the negative electrode?

.....
.....

(1)

(ii) How does a hydrogen ion change into a hydrogen atom?

.....
.....

(1)

(b) Hydrogen is used to make ammonia (NH₃).

Complete the diagram to show the bonding in ammonia.

Use dots (•) and crosses (x) to show electrons.

Show only outer shell electrons.

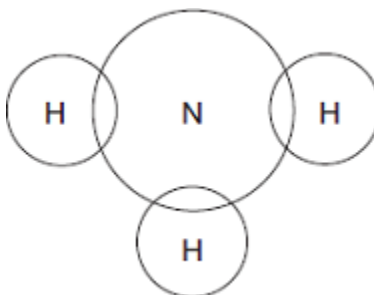

(2)

(c) The table shows the ions in sodium chloride solution.

Positive ions	Negative ions
hydrogen	chloride
sodium	hydroxide

In industry, some of the waste from the electrolysis of sodium chloride solution is alkaline and has to be neutralised.

(i) Which ion makes the waste alkaline?

.....

(1)

(ii) This waste must be neutralised.

Write the ionic equation for the neutralisation reaction.

.....

(1)

- (d) *In this question you will be assessed on using good English, organising information clearly and using specialist terms where appropriate.*

The electrolysis of sodium chloride solution also produces chlorine and sodium hydroxide.

In industry, the electrolysis of sodium chloride solution can be done in several types of electrolysis cell.

Some information about two different types of electrolysis cell is given below.

	Mercury cell	Membrane cell
Cost of construction	Expensive	Relatively cheap
Additional substances used	Mercury, which is recycled. Mercury is toxic so any traces of mercury must be removed from the waste	Membrane, which is made of a polymer. The membrane must be replaced every 3 years.
Amount of electricity used for each tonne of chlorine produced in kWh	3400	2950
Quality of chlorine produced	Pure	Needs to be liquefied and distilled to make it pure.
Quality of sodium hydroxide solution produced	50% concentration. Steam is used to concentrate the sodium hydroxide solution produced.	30% concentration. Steam is used to concentrate the sodium hydroxide solution produced.

Use the information and your knowledge and understanding to compare the environmental and economic advantages and disadvantages of these **two** types of electrolysis cell.

.....

.....

.....

.....

.....

.....

.....

.....

.....

.....

.....

.....

.....

.....

.....

.....

.....

.....

.....

.....

.....

.....

.....

(6)
(Total 12 marks)

This question is about zinc and magnesium.

Zinc is produced by electrolysis of molten zinc chloride, as shown in the figure below.

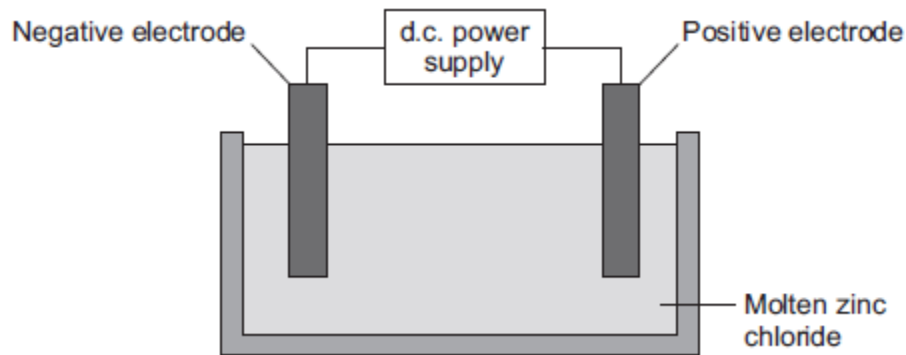

(a) (i) Why must the zinc chloride be molten for electrolysis?

.....

(1)

(ii) Describe what happens at the negative electrode.

.....

(3)

(iii) Complete the half equation for the reaction at the positive electrode.

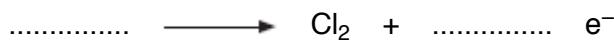

(1)

(b) Magnesium can be produced from magnesium oxide.

The equation for the reaction is:



(i) How can you tell from the equation that the reaction is done at a high temperature?

.....

(1)

(ii) This reaction to produce magnesium from magnesium oxide is **endothermic**.

What is meant by an **endothermic** reaction?

.....
.....

(1)

(iii) A company made magnesium using this reaction.

Calculate the mass of magnesium oxide needed to produce 1.2 tonnes of magnesium.

Relative atomic masses (A_r): O = 16; Mg = 24

.....
.....
.....
.....

Mass of magnesium oxide needed = tonnes

(3)

(iv) The company calculated that they would produce 1.2 tonnes of magnesium, but only 0.9 tonnes was produced.

Calculate the percentage yield.

.....
.....

Percentage yield = %

(1)

(v) Give **one** reason why the calculated yield of magnesium might not be obtained.

.....
.....

(1)

(Total 12 marks)

Mark schemes

1	(a) electrolytes	1
	(b) oxidation	1
	electrons lost	1
	(c) $2\text{H}^+ + 2\text{e}^- \rightarrow \text{H}_2$ <i>minus sign on e⁻ not needed</i>	2
	(d) concentration increases	1
	OH ⁻ discharged from water / water decomposes	1
	H ⁺ concentration increases / H ₂ and O ₂ evolved	1
		[8]
2	(a) $2\text{Cl}^- - 2\text{e}^- \rightarrow \text{Cl}_2$ (allow unaltered LHS to produce $\frac{1}{2}\text{Cl}_2$) $\text{Na}^+ + \text{e}^- \rightarrow \text{Na}$ (allow $\times 2$ for all terms) (<i>credit</i> candidates who point out that hydrogen / H ₂ is in fact produced) <i>for 1 mark each</i>	2

(b) for product 1*, *idea of a solid / precipitate* **or** silver bromide
gains 1 mark

but solid / a precipitate of silver bromide
gains 2 marks

for product 2*, *idea of aqueous / a solution / dissolved (in water) / or sodium nitrate*
gains 1 mark
(do not allow liquid)

but aqueous / a solution / dissolved (in water) of sodium nitrate

(*do not credit formulae)
gains 2 marks

4

[6]

3

(a) any **one** from:

- they are negative / anions
allow Cl⁻
ignore atoms / chlorine
*do **not** accept chloride ions are negative electrodes*
- they are attracted
- they are oppositely charged

1

(b) hydrogen is less reactive than sodium

1

(c) hydroxide (ions) / OH⁻

ignore OH
*do **not** accept NaOH / sodium hydroxide*

1

(d) (i)

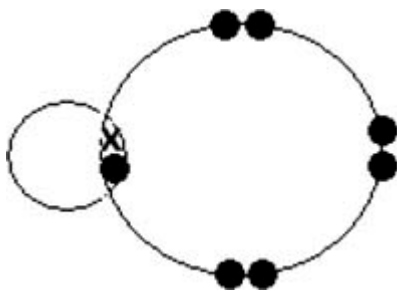

allow any combination of dots or crosses
ignore chemical symbols

1

(ii) covalent
allow close spelling errors
apply list principle 1

(iii) hydrogen (ion) / H⁺
ignore (aq) / H
do not accept hydrochloric acid / HCl
apply list principle 1

[6]

4

(a) hydrogen
for 1 mark 1

(b) chloride ions are negative;
negative ions move to positive electrode
each for 1 mark 2

(c) any **one** use of chlorine e.g.
sterilisation;
bleaching;
making plastics
any one for 1 mark 1

[4]

- 5**
- (i) hydrogen, hydroxide and sulphate
*all **three** and no others*
any order
do not credit any formula(e) 1
- (ii) the anode is positive 1
- (so) only the negative ions are attracted to it
or (so) only the hydroxide ions and the sulphate ions are attracted (to it)
or (so) only the anions are attracted (to it) 1
- (iii) $2\text{H}_2\text{O} + \text{O}_2 + 4\text{e}^-$ 1
- [4]**

- 6**
- (a) sodium hydroxide / caustic soda / NaOH
for 1 mark 1
- (b) negative ions move to the positive electrode etc.
 /because it is negative
 /opposite charges attract
for 1 mark 1
- (c) loss of electrons
for 1 mark 1
- [3]**

- 7**
- (a) Gas A = Chlorine / Cl_2 not Cl and Gas B = Hydrogen / H_2 not H
for 1 mark
- Solution C = sodium hydroxide/NaOH/spent brine
for 1 mark 2

- (b) (i) 2, 2
for 1 mark
- (ii) 2, 2
for 1 mark
- (c) water/H₂O/hydrogen oxide not hydrogen hydroxide
for 1 mark
- (d) ions/positive ions/negative ions/cations/anions
not charged particles/positive particles/negative particles
not H⁺ / Cl⁻/Na⁺ / OH⁻
Allow hydrogen ions etc.
not sulphate ions
for 1 mark

2

1

1

[6]**8**

- (a) (i) hydrogen/H₂
for 1 mark
- (ii) i.e. $2\text{Cl}^- - 2\text{e}^- \rightarrow \text{Cl}_2$
for 1 mark
- (iii) hydroxide or OH⁻
for 1 mark
- (iv) sodium hydroxide/caustic soda/NaOH/bleach/
chemical name of bleach
for 1 mark
- (b) (i) Na₂CO₃ or (Na⁺)₂ CO₃²⁻
for 1 mark
- (ii) coal
water/H₂O
limestone/CaCO₃/calcium carbonate
any one for 1 mark

1

1

1

1

1

1

- (iii) calcium chloride/ CaCl_2 /sodium hydrogen carbonate/ NaHCO_3
for 1 mark 1
- (iv) decomposition/heating of limestone
 decomposition/heating of coal
 decomposition/heating of sodium hydrogen carbonate
any 1 for 1 mark 1
- described change e.g. $\text{NaHCO}_3 \rightarrow \text{Na}_2\text{CO}_3$
 (Use judgement)
 breakdown (owtte.)
 by heat
for 1 mark each 2
- (v) carbon dioxide/ CO_2 or ammonia/ NH_3
for 1 mark 1
- (c) (i) zinc carbonate/ ZnCO_3 /zinc hydroxide/ Zn(OH)_2
for 1 mark 1
- (ii) It is insoluble
 zinc carbonate is insoluble in water
for 1 mark 1

[13]

9

- (a) substance brokendown / separates / splits into elements
 by electric current / electricity
 ions free to move e.g. when molten / in solution
allow 1 mark for "a substance that conducts electricity" max 2
- (b) (i) copper / Cu 1
- (ii) oxygen / O_2
allow CO_2 1

- (c) tube over electrode
 full of $\text{CuSO}_4(\text{aq})$ / water
allow sulphuric acid / sensible electrolyte
not any other liquid / using a syringe 2
- (d) Cu^{2+} ions removed / less Cu^{2+}
not copper sulphate removed
allow 1 mark for "copper removed / less copper" 2

[8]

10

- (a) breakdown / decomposition / splits into elements /
not ions
 separates into elements / produce a chemical reaction 1
 using electricity 1
- (b) lead bromide melted / free ions
 not electrolyte 1
- (c) (+) bromine
element must be appropriate to electrode 1
- (-) lead
element must be appropriate to electrode 1
- (d) fume cupboard / protective clothing
allow safety glasses
not safety mat 1

[6]

11

- (i) electrolysis 1
- (ii) oxidation 1

- (iii) hydroxide ions **or** OH⁻
*accept sodium hydroxide **or** hydroxide **or** OH for one mark only* 2
- (iv) H⁺ + e⁻ 1
- H₂
ignore any state symbols 1
- 2H⁺ + 2e⁻ → H₂
*accept H⁺ + e⁻ → H for **one** mark only* 1

[7]

12

- (a) hydrogen
accept H₂
*do **not** accept H* 1
- (b) litmus paper / Universal Indicator paper / pH paper
allow any suitable named indicator 1
- bleached / turns white **or** loses its colour
*do **not** accept bleached cloth / leaves etc.*
allow second mark unless incorrect indicator given
allow starch iodide paper (1)
goes black / blue black (1)
allow potassium iodide solution (1) goes brown / orange / black precipitate (1) 1
- (c) because they have a negative charge **or** opposite charges attract
accept (because) it is Cl⁻
*accept chlorine, Cl **or** chlorine ions has a negative charge*
*do **not** accept Cl⁻ on its own*
*do **not** accept Cl₂ o.e. has negative charge* 1
- (d) kill bacteria / germs, etc. **or** sterilise / disinfect
accept destroys bacteria etc.
ignore clean / purify water (owtte)
*do **not** accept just gets rid of bacteria* 1

(e) hydroxide (ion)

accept OH⁻

1

[6]

13

(a) (i) bulb lights up

1

bubbles / fizz / gas or chlorine given off

1

(ii) in solid, ions

1

are not free to move / (charged) particles cannot move or converse
atoms / electrons cannot move worth 0 marks

1

(b) (i) breakdown / decomposition / splitting up

not separation

1

by using electricity

1

(ii) gas **A** = chlorine / oxygen

1

deposit **B** = copper

1

(c) any one from:

- manufacturer of chlorine / sodium hydroxide / hydrogen / sodium
- electroplating of steel / reference to plating
not galvanising
- extraction of aluminium / metal reactivity series specified
- purification of copper
not making copper

1

[9]

(a) (propanone) has a low(er) boiling point
or water has a high(er) boiling point or water evaporates slow(er)

or (propanone) evaporates fast(er) owtte
allow propane / solution / it
allow evaporates at lower temperature or boils quicker
ignore density / reactivity / melting point

1

(b) (i) 0.29

ignore + or –
ignore units

1

(ii) any **two** sensible suggestions eg:

- weighing error
accept human error or inaccurate measurements
- (copper) lost during washing owtte
allow different washing of electrodes
- (copper) lost during electrolysis / reaction owtte
- electrodes not completely dry
- impurities in the electrode
- copper falling off when removing electrode / copper from cell
ignore timing errors
ignore 'fair test'
ignore sludge
ignore gases produced

2

(c) any **four** from:

- impure copper is anode / positive (electrode)
- pure copper is cathode / negative (electrode)
- copper sulfate solution **or** any soluble copper salt in solution
- copper loses electrons **or** copper is oxidised(*)
- copper forms positive ions / particles(*)
()as alternative to these two points $Cu \rightarrow Cu^{2+} + 2e^- = 2$ marks*
- copper gains electrons **or** copper reduced at negative electrode
***or** $Cu^{2+} + 2e^- \rightarrow Cu$ at negative electrode*
- copper attracts to / collects at negative electrode
- sludge / impurities collect at the bottom owtte
*allow sludge left behind **or** sludge left in solution **or** impurities separated from copper*
- impurities not attracted to electrode
ignore get rid of impurities

4

[8]

15

(a) electric current / electricity

1

plus **one** from:

- is passed through ionic compound / substance / electrolyte
- passed through molten/aqueous compound / substance
must be linked to electricity
allow liquid compound / substance
*do **not** allow solution / liquid alone*
- causing decomposition
accept split up / breakdown / breaking up owtte
ignore separated
accept elements are formed
ignore new substances form

1

(b) hydrogen
accept H₂
*do **not** accept H / H²* 1

(c) one electron from each atom
accept each carbon is bonded to three other carbon atoms leaving one (unbonded) electron owtte 1

is delocalised / free (to move)
must be linked to electrons
answers of delocalised / free electrons only, gains 1 mark
accept each carbon is bonded to three other carbon atoms leaving delocalised / free electrons = 2 marks
***maximum 1** mark if graphite described as a metal / giant ionic lattice* 1

[5]

16

(a) (i) ionic 1

(ii) elements 1

(b) (i) chlorine (gas)
allow Cl₂ / Cl / Cl²
allow chloride 1

(ii) hydrogen (gas)
allow H / H₂ / H² 1

(iii) sodium hydroxide (solution)
allow NaOH
allow sodium solution 1

[5]

(a)

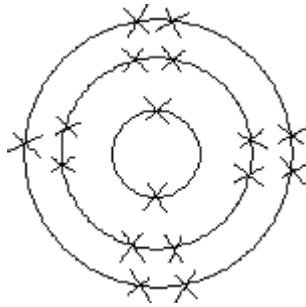

accept dots / crosses / e
 must be drawn on diagram
 electrons do not need to be paired
 ignore brackets or + or -charges
 ignore 2,8,7

1

(b) (one) electron

recognition that electrons are involved

1

lost / given away / transferred from sodium / transferred to chlorine owtte

must be linked to electrons
 accept loses electron(s) for 2 marks
 NB loses 2 or more electrons gains 1 mark
 reference to sharing / covalent max 1 mark
 ignore charges on ions formed

1

(c) (i) any **one** from:

- ions / atoms / they are / it is negatively charged / anions
accept they are negative
- opposite (charges) attract
accept they are attracted or it is oppositely charged
ignore opposite forces attract

1

(ii) hydrogen

accept H_2
 ignore H or H^+

1

(d) (i) poisons released into environment (owtte)

accept any sensible idea of harm / harmful / poisons / poisonous /
 pollution / damaging
 do **not** accept answers such as global warming / ozone layer etc.
 ignore safety unless qualified

1

- (ii) any **one** sensible idea eg
- loss of work / unemployment
eg shops / house prices etc.
- or**
company goes out of business
- any adverse effect on local economy (owtte)
 - any adverse effect on paper production / cost of paper / cost of water (treatment)
allow less expensive to use chlorine or converse
 - chlorine (compounds) have been used (for many years) without causing harm owtte
 - only a tiny amount of chlorine is released so it would not cause harm
ignore uses of chlorine to treat drinking water unless qualified
- 1
- (iii) ideas related to bias
- accept more reliable or valid or fair*
- ignore more accurate / fair test*
- 1

[8]

18

- (a) cannot move
- 1
- (b) water
- 1
- (c) (i) a positive charge
- 1
- (ii) atoms
- 1

[4]

19

- (a) (i) electron(s)
- allow free / delocalised / negative electrons*
- do **not** accept additional particles*
- 1

(ii) ion(s)
allow named ions from table
ignore positive or negative
*do **not** accept additional particles*

1

(b) (i) copper
accept Cu
*do **not** accept Cu^{2+}*

1

(ii) it is / they are positive (ions)
accept formula of positive ion

1

and it is the least reactive

1

(c) (i) loss of electron(s)
ignore numbers

1

(ii) $2\text{H}^+ + 2\text{e}^- \rightarrow \text{H}_2$
accept correct multiples / fractions
accept e / e^-
allow $2\text{H}^+ \rightarrow \text{H}_2 - 2\text{e}^-$

1

[7]

20

(a) the ions can move / travel / flow / are free
accept particles / they for ions
allow delocalised ions

or

ignore delocalised / free electrons
ignore references to collisions
accept converse with reference to solid

the ions carry the charge / current
ignore ions carry electricity

1

- (b) any **one** from:
- because they are negative / anion
allow Cl⁻
ignore chlorine
 - opposite charges / attract
- 1
- (c) 13
- 1
- (d) (i) reasonable attempt at straight line which misses the anomalous point
must touch all five crosses
*do **not** allow multiple lines*
- 1
- (ii) 40
ignore 2.2
- 1
- (iii) any **two** sensible errors from:
ignore systematic / human / apparatus / zero / experimental / random / measurement / reading errors unless qualified
- gas escapes
 - weighing error
allow NaCl not measured correctly
 - error in measuring (volume / amount) of hydrogen
 - error in measuring (volume / amount) of water
*allow error in measuring volume / scale for **1** mark if neither hydrogen or water mentioned*
 - incorrect concentration
*allow NaCl not fully dissolved **or** spilled **or** impure*
 - timing error
 - change in voltage / current
allow faulty power supply
 - change in temperature
 - recording / plotting error
- 2

- (iv) any **one** from:
ignore 'do more tests'
- repeat the experiment
 - results compared with results from /other students / other groups / other laboratories / internet / literature.
 - results compared with another method
- 1
- (v) increases owtte
allow directly proportional or positive correlation
allow rate / it is faster / quicker
- 1

[9]

21

- (a) (i) was well qualified
- 1
- (ii) check the results of the experiment
- 1
- (b) (i) cannot move
- 1
- (ii) melt it / make it a liquid
allow heat it
allow dissolve (in water) / make a solution
- 1
- (iii) they are positive
*allow opposites attract **or** opposite charges*
- 1
- (iv) atoms
- 1

[6]

22

- (a) cannot move
- 1
- (b) (i) a positive charge
- 1
- (ii) atoms
- 1

[3]

23

- (a) (i) current / charge couldn't flow
allow could not conduct (electricity)
- 1

because the ions / particles couldn't move
*do **not** accept electrons/ molecules / atoms*

or

(salt) needs to be molten / (1) dissolved (to conduct electricity)

so that the ions / particles can move (1)
*do **not** accept electrons / molecules / atoms*

1

(ii) he had status
*accept he had authority **or** experience*

or

he had evidence / proof
accept the experiment could be repeated

1

(b) hydrogen / H₂
*do **not** allow hydrogen ions*

1

the ions are positive
accept because opposite (charges) attract

1

potassium is more reactive (than hydrogen)
*accept potassium ions are less easily discharged (than hydrogen)
or potassium ions are less easily reduced (than hydrogen)*

1

(c) (i) gain electron(s)
*accept fully balanced correct equation for **2** marks*

1

one electron
*if no other marks awarded allow (potassium ions) reduced for
1 mark*

1

(ii) $2 \text{Cl}^- \rightarrow \text{Cl}_2 + 2\text{e}^-$
*must be completely correct, including charge on electron
accept correct multiples*

1

(iii) 2, 8, 8

accept any combination of dots, crosses, "e" or any other relevant symbol

ignore any charges if given

1

[10]

24

(a) electricity

allow an electric current

1

(b) (i) chlorine/ Cl_2

*do **not** accept chloride*

1

(ii) (zinc ions are) positive

ignore to gain electrons

1

and (opposite charges) attract

1

(iii) reduction

1

(c) (i) in alloy:

accept converse

different sized atoms/particles

or

no layers/rows

accept layers distorted

1

so cannot slide

1

(ii) shape memory (alloys)

accept smart

1

[8]

25

(a) (i) because they are positively charged

accept they are positive / H^+

*accept oppositely charged **or** opposites attract*

ignore they are attracted

1

(ii) gains one / an electron

accept $H^+ + e^- \rightarrow H$ or multiples

allow gains electrons

1

(b) 3 bonding pairs

1

1 lone pair

accept 2 non-bonding electrons on outer shell of nitrogen

1

(c) (i) hydroxide / OH^-

*do **not** accept sodium hydroxide*

1

(ii) $H^+ + OH^- \rightarrow H_2O$

ignore state symbols

ignore word equation

1

(d) Marks awarded for this answer will be determined by the Quality of Written Communication (QWC) as well as the standard of the scientific response. Examiners should also refer to the information in the Reference material.

0 marks

No relevant content.

Level 1 (1-2 marks)

There are basic descriptions of advantages or disadvantages of the electrolysis cells.

Level 2 (3-4 marks)

There are clear descriptions of environmental or economic advantages or disadvantages of the electrolysis cells. Comparisons may be implied.

Level 3 (5-6 marks)

There are detailed descriptions of environmental and economic advantages and disadvantages, comparing the electrolysis cells.

Examples of chemistry points made in the response:

Accept converse where appropriate.

- mercury cell is more expensive to construct
- mercury is recycled but membranes must be replaced
- mercury is toxic but membrane / polymer is not
- removing traces of mercury from waste is expensive
- mercury cell uses more electricity
- mercury cell produces chlorine that is purer
- mercury cell produces higher concentration / better quality of sodium hydroxide (solution)

6

[12]

- (a) (i) so ions can move (and carry charge)
accept so current can flow
allow so it can conduct (electricity)
allow so charged particles can move
 do **not** accept so electrons can move

1

- (ii) because zinc ions gain electrons
accept because zinc ions are reduced

1

2 (electrons)

1

zinc is formed

accept correct half equation for 3 marks
if no mark gained allow
positive ions go to negative electrode or
opposites attract or
reduction (of zinc) or
(zinc) gains electrons for 1 mark

1

- (iii) $2 \text{Cl}^- \longrightarrow \text{Cl}_2 + 2 \text{e}^-$
must be completely correct

1

- (b) (i) because the magnesium is a gas
allow magnesium goes from solid to gas

1

- (ii) (a reaction which) takes in energy (from the surroundings)
accept more energy needed to break bonds than released by forming bonds
accept correct reference to energy level diagram
allow (a reaction which) takes in heat (from the surroundings)

1

- (iii) ($M_r \text{MgO} =$) 40
accept ($2 M_r \text{MgO} =$) 80

1

1.2 / 24 (x40) or 0.05 (x40)

or

40 / 24 (x1.2) or 1.67 (x1.2)
allow ecf from step 1

1

2(.0)

allow ecf carried through from step 1
correct answer with or without working gains 3 marks

1

(iv) 75(%)

1

(v) any **one** from:

- the reaction is reversible
accept incomplete reaction
ignore equilibrium not reached
- *some lost / escaped / released (when separated)*
- some of the reactant may react in different ways from the expected reaction
- *impure reactant(s)*
ignore measurement and calculation errors

1

[12]

Examiner reports

1

This question discriminated well between the more able candidates. Part (a) was largely answered correctly, although for many candidates this was the only mark gained in this question. The loss of electrons in part (b) was not noticed by many candidates, so subsequently this reaction was not linked to oxidation. A lot of candidates knew the answer to part (c) but failed to link the reaction to hydrogen ions. Part (d) was mostly answered incorrectly with only the more able candidates realising that, overall, water was being lost. The majority of candidates recognised water as a product in part (b) and, if they got that far, loss of hydrogen ions in part (c), and therefore assumed that the acid was being diluted.

3

- (a) The idea of opposites attracting was well understood and most students appreciated that the chloride ion must be negatively charged.
- (b) A significant proportion of students gave 2 responses instead of the required 1, including one of the statements about hydrogen that was factually correct, but not the reason why hydrogen rather than sodium was produced at the electrode.
- (c) Only a small minority of students knew that the hydroxide ion is the cause of alkalinity, with many giving sodium (Na^+) or hydrogen (H^+), which had been identified earlier in the question.
- (d) (i) The concept of a shared pair of electrons, one from each atom, in the overlap was well understood. The most common error was to place the hydrogen electron in the same position as shown in the diagram of the hydrogen atom rather than in the overlap.
- (ii) Was well known with ionic being the most likely incorrect response.
- (iii) That hydrogen was the ion that caused the solution to be pH1 was better known than the hydroxide ion, though a surprising number of students gave hydrogen as the response for both this and the alkalinity question.

4

Sodium was surprisingly given as the gas from the negative electrode. Most candidates realised that chlorine was negative and attracted to the anode but did not realise it was an ion. While many candidates said chlorine was used in swimming pools they did not qualify the answer by mentioning its effect – killing microbes.

5 In part (i), very few candidates could recognise and write down the names of all three ions mentioned in the passage

Part (ii) was well answered.

A minority of students successfully completed the equation in (iii), but most made an attempt.

7 (a)/(b) These were often well answered.

(c)/(d) Fewer candidates were able to answer these. In part (d) many gave the answer “electrons” rather than ions.

8 This proved a very difficult question for many of the candidates. The whole of part (a) caused problems but parts (iii) and (iv) were rarely answered correctly.

As in question 9 (c) many of the candidates were unable to work out the formula of a compound in part (b) (i), NaCO_3 was a common answer. Parts (b) (ii), (iii) and (iv) were often well answered although some candidates failed to explain what is meant by decomposition in (iv).

Few candidates showed any understanding of the precipitation reaction in part (c).

9 **Paper 3 Foundation Tier**

This question caused problems for weaker candidates because they could not express themselves clearly enough to adequately answer some sections. The definition of ‘electrolyte’ rarely produced a sensible statement beyond a reference to conduction of electricity. In (b), the identity of the gas was often correctly given but ‘hydrogen’ was also suggested. The need to place a test-tube full of liquid over the electrode was only occasionally recognised and the reason for the loss of colour of the solution was rarely attributed to discharge of copper ions (although loss of copper was sometimes suggested).

Paper 5 Higher Tier

Part (a) was generally well answered. Many candidates repeated the 'electrolysis' stem of the question instead of mentioning electricity. Lots of vague 'separated' answers including ... into the ions'. A number talked about free electrons carrying the current. Part (b)(i) was very well answered and seldom wrong. Part (b)(ii) was often wrong – hydrogen and sulphur dioxide were predictably by far the most frequent errors. A surprising number put carbon dioxide which is correct with graphite electrodes. In part (c) there were many correct answers, though relatively few filled the tube with electrolyte for the second mark. It was sometimes implied by talking about displacement of the electrolyte. Common errors involved funnels and gas syringes, but many more elaborate contraptions were seen involving pneumatic troughs, beehive shelves, gas jars and much more! In (d) many put removal of copper sulphate and got nothing, but many others knew that the colour was due to copper in the solution. Only the best candidates mentioned copper ions.

10

Electrolysis was poorly defined and vague statements such as 'separates the substances' were common; electricity was often not mentioned! In (b). the idea of freeing of ions so that a current can be carried was rarely seen. Answers to (c) and (d) were usually satisfactory although the safety precautions suggested by some were general rather than specific to the experiment in the question.

11

Double and Single Award

The process of electrolysis was known to most candidates. The loss of electrons from the chloride ion was understood as oxidation by most. of the more able candidates. In (iii) there was a lack of understanding about the OH^- ion being responsible for causing the solution to be alkaline. Some referred to the alkalinity being due to the sodium hydroxide, without any specific reference to the hydroxide ion as being the cause. The balanced ionic equation for the formation of hydrogen gas was rarely given correctly.

Foundation Tier

- (a) Many candidates were unable to identify the gas as hydrogen. Common incorrect responses were sodium, oxygen and carbon dioxide.
- (b) Few candidates knew this test but a surprisingly large number gave limewater or a burning splint.
- (c) This part was often well answered with candidates realising that the chloride ions must have a negative charge.
- (d) Answers such as 'to clean the water' were not sufficient to gain this mark. The idea that chlorine kills bacteria / microbes was required. Some candidates thought that chlorine neutralises the water or improves the taste of the water.
- (e) Very few candidates knew that hydroxide ions make a solution alkaline. Many candidates stated sodium, hydrogen or sodium hydroxide.

Higher Tier

This was generally a well answered question.

- (a) Hydrogen was known by the more able candidates. Carbon dioxide, oxygen and sodium were common incorrect responses.
- (b) Most candidates correctly described the test for chlorine. Some did not name the indicator to be used, while others did not know the result of the test. Some candidates used a lighted splint or suggested a flame test, while a fair number tested for chloride ions.
- (c) This part was very well answered. The majority of candidates correctly linked the negative charge on the chloride ion with its attraction to the positive electrode.
- (d) Almost all candidates knew that chlorine was used to kill bacteria to make drinking water safe. Incorrect responses centred around the removal of hardness or the prevention of tooth decay.
- (e) Only the more able candidates seemed to know the OH^- ions caused the solution to be alkaline. Incorrect responses included Na^+ , Na, NaCl, NaOH and CO_3^{2-} .

Paper 3 Foundation Tier

Parts of this question proved to be difficult for many candidates, often because they did not carefully consider what the examiner was asking of them. In part (a)(i), observations were required but candidates simply named the products and did not state what would be seen. Few correct answers were written for (a)(ii) since there was very rarely any reference to 'ions' and the need for them to be able to move through the electrolyte. In part (b), the definition of 'electrolysis' was flawed because it was not made clear that there was a chemical reaction occurring at the electrodes leading to the 'breakdown' of the electrolyte; 'separation of the copper chloride by electricity' was a common type of answer scoring only one mark. Part (b)(ii) was often correct, The answers to part (c) were disappointing - often because of a lack of clarity.

Paper 5 Higher Tier

Parts of this question proved to be difficult for many candidates, often because they did not carefully consider what the examiner was asking of them. In part (a)(i), *observations* were required but candidates simply named the products and did not state what would be seen. Part (a)(ii) discriminated well. Vague answers referring to electrons, atoms, particles and molecules were common. In part (b), the definition of 'electrolysis' was flawed because it was not made clear that there was a chemical reaction occurring at the electrodes leading to a 'breakdown' of the electrolyte; 'separation of the copper chloride by electricity' was a common type of answer scoring only one mark. Part (b)(ii) was often correct. The answers to part (c) were disappointing - often because of a lack of clarity.

Foundation Tier

These were standard demand questions which aimed to differentiate between grades C and D. Perhaps not surprisingly, a significant number of candidates, between 10% and 20%, did not attempt some parts of these questions. All parts were, however, successfully completed by many candidates and the questions differentiated successfully between the higher grades on this paper.

Part (a) saw a large number of the candidates able to make the link between the low boiling point of propanone and the fact that it would evaporate faster. A simple statement such as, it has a low boiling point, was all that was required.

Part (b)(i) was correctly calculated by many candidates. A few candidates gave the answer 29 rather than 0.29 g.

Part (b)(ii) was not well answered. Many candidates simply restated information given in the question that the mass lost and gained was not the same. Some were distracted by the lamp suggesting ideas such as more electricity going to one electrode than the other. Timing errors or differences in the size or mass of the electrodes were not accepted. Similarly we did not accept answers such as, there was not enough power, it was not a fair test or the experiment was only done once.

A wide range of answers was accepted such as:

- weighing errors
- electrodes not being completely dry
- impurities in the electrodes
- mass lost in the washing process
- bits of copper falling off the electrodes

Answers to part (c) were disappointing given that this is one of only two electrolyses that are specifically given in the specification. The mark scheme was broad and allowed candidates to gain marks in a number of different ways. For example a simple answer such as, the impure copper is the positive electrode and a piece of pure copper is the negative electrode. The electrodes are dipped in copper sulfate solution. Pure copper collects on the negative electrode, was sufficient to gain four marks.

A number of misconceptions were seen. For example, some candidates thought that the impure copper would be melted and then two electrodes would be dipped into the molten mixture. Other candidates thought that pure copper atoms would be positive and impure copper atoms would be negative. Some candidates talked about positive and negative electrons where they perhaps meant electrodes.

Higher Tier

For part (a) most of the candidates were able to make the link between the low boiling point of propanone and the fact that it would evaporate faster. A simple statement such as, it has a low boiling point, was all that was required.

Part (b)(i) was correctly calculated by the vast majority of the candidates. A few candidates gave the answer 29 rather than 0.29 g.

Part (b)(ii) was less well answered. Many candidates simply restated information given in the question that the mass lost and gained was not the same. Some were distracted by the lamp suggesting ideas such as more electricity going to one electrode than the other. Timing errors or differences in the size or mass of the electrodes were not accepted. Similarly we did not accept answers such as, there was not enough power, it was not a fair test or the experiment was only done once.

A wide range of answers was accepted such as:

- Weighing errors
- Electrodes not being completely dry
- Impurities in the electrodes
- Mass lost in the washing process
- Bits of copper falling off the electrodes

There were some excellent answers to part (c) but in general answers were disappointing given that this is one of only two electrolyses that are specifically given in the specification. The mark scheme was broad and allowed candidates to gain marks in a number of different ways. For example a simple answer such as, the impure copper is the positive electrode and a piece of pure copper is the negative electrode. The electrodes are dipped in copper sulfate solution. Pure copper collects on the negative electrode, was sufficient to gain four marks.

Alternatively some of the more able candidates gave more sophisticated answers such as, Copper atoms at the positive electrode lose electrons to form positive ions. The positive copper ions attract to the negative electrode where they gain electrons to form copper atoms. This would also gain four marks.

A number of misconceptions were seen. For example, some candidates thought that the impure copper would be melted and then two electrodes would be dipped into the molten mixture. Other candidates thought that pure copper atoms would be positive and impure copper atoms would be negative. Some candidates talked about positive and negative electrons where they perhaps meant electrodes.

Some candidates were obviously confused about the meaning of the terms anode and cathode. These are not required in the specification and candidates might find it simpler to refer to positive and negative electrodes.

15

Many candidates found difficulty in explaining the meaning of the term electrolysis in part (a). These candidates knew that it was something to do with electricity but could not give any further information. Other candidates did not mention electricity but simply talked about the movement of ions.

The majority of candidates gave the correct response which was hydrogen in part (b). A variety of incorrect responses were seen including oxygen, chlorine and sodium oxide. In part (c) many of the candidates gained one mark for the idea of delocalised electrons. Fewer candidates were able to give a more detailed answer which explained that each carbon atom has one free electron. Some candidates thought that graphite must be a metal.

16

About half the candidates correctly answered part (a)(i) and part (a)(ii). All of the responses were seen.

All permutations were seen in part (b). Oxygen and sodium metal were frequently given. The best known answer was substance A, chlorine. Substance C, sodium hydroxide solution, was the least well known.

17

- (a) It is pleasing to note that the majority of the candidates were able to correctly complete the electronic structure of the chlorine atom. A number were penalised because it was unclear whether they had crossed out erroneous electrons.
- (b) A good number of the candidates were able to make a good attempt at this question, which is a topic they have often found difficult in the past. Some excellent detailed answers were seen which mentioned full outer shells of electrons and ideas such as ions are atoms where the number of protons and electrons are unbalanced. Poor answers included ideas such as transfer of atoms, ions or neutrons. Better answers mentioned electrons but many candidates discussed sharing of electrons or the chlorine atom giving the sodium atom electrons. Others candidates hedged their bets and discussed the sodium losing and gaining electrons. Some thought that the sodium atom would gain a proton.
- (c) (i) Generally well answered.
- (ii) Hydrogen was less well known. Many candidates made guesses and gave answers such as sodium chloride or a wide variety of chemical elements.
- (d) (i) Nearly all candidates gained credit.
- (ii) A number of the candidates missed the point and gave answers such as chlorine is needed to treat drinking water.
- (iii) A fair number of the candidates correctly used their knowledge of How Science Works and gave answers linked to the independent scientists not being biased. Answers to do with accuracy or fair test were ignored since they did not answer this question.

(a) and (b) Parts (a) and (b) were both well answered. The most common incorrect responses were 'are too small' in part (a) and 'petrol' in part (b).

- (c) (i) The vast majority of the candidates chose the correct property, 'a positive charge'.
- (ii) The type of bonding was less well known in this part with a substantial number of candidates choosing 'compounds' or 'molecules'.

Electrolysis is often a challenging topic, and this question was no exception. It was, however, very discriminating, enabling stronger candidates to demonstrate their understanding of this important area of chemistry. In question 5(a)(i) and 5(a)(ii) the majority of candidates were able to name electrons as the current carriers in the metal wires, but only a minority could identify ions as the current carriers in the solution.

- (a) (i) the most common error was giving the name of the metal - ie copper, rather than the name of the particle. A number of candidates gave more than one type of particle, eg 'electrons and protons'. This was treated as a list by examiners, so the incorrect inclusion of protons meant that no credit could be given for electrons.
- (ii) Common errors included electrons, protons, neutrons, water. The wide variety of incorrect particles given suggested that only the more able had an awareness of the charge carriers in solution.
- (b) (i) This question, along with the accompanying explanation in part (a)(ii), was challenging even for A* candidates, as it required the ability to understand and apply the concept of reactivity to electrolysis. The most common incorrect element given was zinc, but a significant minority of candidates gave Cu^{2+} or copper(II) ion, rather than the symbol or name of the element. The question asked for the element formed, so copying copper(II) ions from the table gained no credit. Although metals were most often given, non-metals also appeared frequently.
- (ii) This question elicited some accurate and well expressed responses. It was marked independently of part (b)(i). Most candidates gained one mark for indicating that the element should form positively charged ions, thereby showing a clear understanding of the concept of opposite charges attracting. However, only the most able candidates gained credit for realising that the least reactive element was discharged. Most incorrect answers related to zinc, stating it was discharged because it was the most reactive. Others suggested that iron(III) was discharged as it has the highest positive charge, so was most strongly attracted. The most common response was 'zinc is the most reactive positive ion', gaining one mark. A lot of confusion in terminology was apparent, for example the use of ions for electrons, atoms for ions, ion for electrode and vice versa. Examiners read about positive electrons and answers referring to the highest charged ion or the most reactive element as the 'strongest' ion or element. Some candidates felt that high reactivity caused greatest attraction to the cathode.
- (c) (i) While electron loss is widely known as oxidation, many candidates were unable to state in this context which particle was lost with atoms, ions and protons being suggested. Many of the incorrect answers stated that oxidation was the gain of electrons. Others expanded OIL (as in RIG), but failed to apply the learning aid to the equation given in the question. Some answers focussed on the loss or gain of oxygen rather than electrons. Others focussed on the change in the charge on the ions.
- (ii) Although only a minority of candidates gained credit there were some valiant attempts at this question. Some candidates introduced other elements, eg Na or Cu, or turned the final H_2 into H_2O . Many others gave e^+ , or subtracted electrons on the left hand side of the equation. A number of candidates didn't recognise this as a half equation, so didn't include any electrons, for example simply adding H^+ or H^- on the left hand

side. Many candidates managed nearly correct answers, for example with just a sign or charge wrong. This suggests that candidates may have tried to learn the half equations without understanding them.

20

- (a) This part was answered incorrectly by the vast majority of candidates. Many discussed the conduction of the electricity by atoms or electrons without reference to ions. The idea of oppositely charged particles attracting was also common. Only a small number were able to identify the role of moving ions.
- (b) Most answers either stated that chloride ions were negative or that opposite charges attract. Poor answers involved reference to negative electrodes and positive charge.
- (c) This part was surprisingly poorly answered. The most popular responses were pH 5 and pH 7.
- (d) (i) Many candidates correctly drew a straight line through 5 points missing out the anomalous point. Some lines only went through some of the points while others included the anomalous point and these lines were not given credit. Multiple lines and curves were also penalised. There was also evidence of lines drawn in ink or candidates with no eraser as a number of answers contained crossed out lines or annotations pointing to the “wrong” line. In some of these it was very difficult for examiners to distinguish which part of the line candidates intended to be their correct answer.
- (ii) The anomalous result was often correctly identified though 2.2 was a common error and wild guesses were also evident.
- (iii) This part discriminated very well between the candidates. Weaker answers were vague and candidates often wrote at length but without the required detail to gain credit. Common examples of vague answers were; ‘experiment was done wrong’, ‘there was a mistake or error’, ‘equipment was faulty’ and ‘incorrect measurement’. There were frequent references to human, random and systematic errors, which received no credit unless they were further qualified with a specific idea e.g. error in weighing out sodium chloride or measuring the volume of the hydrogen.
- (iv) This part was answered correctly by the vast majority of the candidates. The most common correct responses were those with the idea of repeating the experiment or comparing results with others. A few vague responses such as ‘do more tests’ or ‘average results’ received no credit.
- (v) Most candidates realised that there would be an increase in the volume of hydrogen or that it would be produced faster. A minority of candidates confused time and rate and stated that it would take longer.

21

- (a) Many students were able to choose the correct responses.
- (b) (i) Many students successfully identified that the ionic solid would not conduct electricity because ions cannot move. However, the other two responses were often chosen showing a lack of knowledge and understanding.
- (ii) Generally poorly answered with few correct answers seen indicating that the solid needed to be melted or dissolved to make a solution. Numerous answers simply stated 'give it a (positive) charge' or 'add more electrons'. Vague references to adding a metal or reaction with another substance were common.
- (iii) The idea of oppositely charged particles is well understood. Many students did not gain the mark as they only state 'they attract'. Poor responses discussed movement of electrodes and the presence of positive electrons.
- (iv) Guesses were evident with the incorrect answers molecules and electrodes frequently chosen instead of atoms.

22

- (a) Generally students were able to select the correct response to explain why solid silver nitrate did not conduct electricity.
- (b) (i) Most students knew that silver ions were attracted to the negative electrode because they were positively charged.
- (ii) Few students knew that silver ions formed atoms at the electrode with most choosing either the distractors compounds or molecules.

23

- (a) (i) Many students referred to "potassium" rather than a potassium salt. While over half of the students realised either that the solid salt was unable to conduct electricity or that the salt should be molten or in solution to conduct, fewer students indicated the necessary movement of particles to gain the second marking point. A number of students thought that electrons moved through the electrolyte. A small minority of students answered in terms of the reactivity of potassium.
- (ii) There was a wide variety of incorrect responses, often focusing on the reactivity of potassium, or that it was a new and useful metal, or that this method could be used to produce other elements. The answers of the minority of students who gained credit often related to the ideas of Davy having status and Davy having proof or evidence. A small number of students did not give any added value in their response, stating that he was a professor.
- (b) The most able students gave succinct and accurate responses, gaining full credit. Carbon dioxide and chlorine were the commonly mentioned incorrect gases, and students giving these gases had difficulty answering the rest of the question. Answers from weaker students indicated a very poor understanding of basic electrolysis, and therefore no grasp of the relevance of reactivity on the discharge of ions. Some students omitted to mention that hydrogen ions are positive.

- (c) (i) Students are more familiar with describing how ions are formed from atoms, so this question proved to be discriminating as it required more thought, and a minority of students earned both marks. Some students explained why potassium ions are attracted to the negative electrode rather than how they form potassium atoms. A number of students thought that the potassium atom would have a full outer shell of electrons.
- (ii) Although a minority, an encouraging number of students gained this mark. The half equation had to be completely correct, including the correct charge on the electrons to gain credit. Incorrect responses often included potassium atoms or ions.
- (iii) Approximately half of students gained credit, giving a clearly drawn electronic structure of a chloride ion. A chlorine atom structure (2,8,7) was the most commonly seen incorrect response, while some students gave only 6 electrons on the outer shell, suggesting that they thought that a chlorine atom would lose, rather than gain an electron on ionisation.

24

- (a) The majority of students realised that electricity was conducted. A common wrong answer was heat.
- (b) (i) Many students named chlorine as the product of electrolysis at the positive electrode. Incorrect answers such as chloride, zinc and zinc chloride were common.
- (ii) A large number of students showed a lack of understanding and discussed the gaining of electrons which was not what the question asked. The question asked students to explain why the zinc ions move, not what happens when they get to the cathode. Numerous answers just repeated the word 'move' instead of attract.
- (iii) A good discriminating question. Most students thought that when zinc ions gain electrons that the type of reaction was a neutralisation which showed a lack of knowledge and understanding.
- (c) (i) Reference to the presence of different sized particles or disruption of the layers in alloys and consequent inability for the sliding of the particles scored full credit. Vague answers referred to a mixture of atoms and lack of movement of particles and scored no credit.
- (ii) A minority of students correctly named the alloys as shape memory or smart. Thermosetting or thermosoftening were common incorrect responses.

25

- (a) (i) Generally well answered with students stating that the hydrogen ions were positively charged or that opposites attract. Vague answers referred to incomplete shells of electrons and charged electrodes attracting. Incorrect reference to positive electrons was a common error.
- (ii) Credit was given for the idea of obtaining an electron or electrons.
- (b) A good discriminating question. More able students scored both marks for showing clearly 3 bonding pairs of electrons and a lone pair anywhere on the outer shell of the nitrogen atom outside the bonding pairs area. Some students omitted the lone pair while others filled all the shells randomly with numerous electrons.

- (c) (i) A minority of students recognised that hydroxide ions made the waste alkaline. Chloride and sodium were often given and sodium hydroxide was not accepted.
- (ii) The ionic equation was beyond the capability of most students. Word equations and blank spaces were common.
- (d) Most students used all of the space provided to write their answer and there were few blank pages. The majority used the table of cell differences given in the stem of the question to formulate the presentation of their answer.

The word 'cell' was missed in many instances as well as the word 'it' being used for chlorine. All too often there was no reference made to sodium hydroxide with only vague references to concentration. Many students stated that the membrane cell had to be replaced every 3 years but that the mercury cell could be recycled. Many students thought that the cell had to be purified or that mercury produces a higher concentration, sometimes of steam, without specifying that the purpose of each cell was to produce chlorine and sodium hydroxide. Frequent statements from the table for each cell were given without a comparable link though a comparison was often implied.

Some misconceptions were apparent when students were suggesting that the cells produced electricity or that they were comparing running costs.

The most common additional information given that allowed them access to level 3 involved use of fossil fuels with subsequent increased carbon dioxide emissions and references to global warming. Usually if cost was cited there was no further explanation to justify where the money was spent. There were a number of correct comparisons of both electricity consumption per tonne of chlorine and the different sodium hydroxide concentrations produced. Some good answers referred to the toxic effects of mercury leakage on wildlife and the environment.

- (a) (i) A minority of students gained credit. Many referred to the movement of unspecified particles or electrons.
- (ii) There were few completely correct explanations due to confusion between types of particles. Many students referred to positively charged atoms or molecules. However, it was well known that opposites attract.
- (iii) Only a minority of students were able to complete the half equation correctly. Examples of incorrect responses on the left hand side of the equation included Cl, Cl_2^- , Cl^{2-} , 2Cl .
- (b) (i) Many students spotted that the reaction was reversible and suggested that this was why it should be done at a high temperature. Only a minority recognised the significance of the gaseous magnesium.
- (ii) The term “endothermic” is well known.
- (iii) A majority of students were able to calculate the M_r of MgO, but only a minority knew how to continue the calculation. Many went on to calculate $1.2 / 40$. Some students worked out the M_r of MgO to be 56 (ie MgO_2)
- (iv) A high proportion of students gave the correct answer. A few students calculated $1.2 / 0.9$, giving a yield of 133%.
- (v) A majority of students gained credit, often recognising either the reversibility of the reaction or the possible loss of gaseous magnesium.

